



ABB i-bus[®] KNX
Electromotor Valve Drive
ST/K 1.1
Product Manual

Contents		Page
1	Product Manual	1
1	General	3
1.1	Using the product manual	3
1.2	Advantages	4
1.2.1	Notes	5
1.3	Hardware versions	6
1.4	Differences	7
1.5	Possible applications	7
1.6	Special features	8
2	Device technology	9
2.1	Technical data	9
2.2	Connection diagram	11
2.3	Dimension drawing	11
3	Application program	13
3.1	Selection in the product database	13
3.2	Parameter pages	13
3.3	Group objects	13
3.3.1	Characteristics of the group objects	13
3.3.2	Description of the objects	14
3.4	Parameters	16
3.4.1	Valve characteristics	16
3.4.2	Safety and forced operation	17
3.4.3	External interface	19
3.4.4	User-defined valve characteristics	20
3.4.5	Own valve characteristic curve	23
3.4.6	Linear valve characteristic curve	25
4	Commissioning	27
4.1	Installation	27
4.2	Calibration strategies	28
4.2.1	Strategy 1, default	28
4.2.2	Strategy 2, automatic (only for devices from software version 61)	29
4.2.3	Strategy 3, with defined valve lift (only for devices from software version 61)	29
4.2.4	LED display during calibration run	30
4.3	Construction site function	31
4.4	Checking the 0% position	31
5	Planning and application	33
5.1	Valves and valve seals	33
5.1.1	Valve design	33
5.1.2	Valves and valve seals	34
5.2	Limiting the actuating value	34
5.2.1	Maximum actuating value	34
5.2.2	Min. actuating value	35
5.3	Determining the max. actuating value	35
5.3.1	Application	35
5.3.2	Principle	35
5.3.3	Practical application	36
5.4	Monitoring of the actuating value	36
5.4.1	Application	36
5.4.2	Principle	36

ABB i-bus® KNX

Contents

5.4.3	Practical application.....	37
5.5	External interface.....	37
5.5.1	Connections.....	37
5.5.2	Input E1	37
5.5.3	Input E2	37
6	Troubleshooting.....	39
6.1	Reading out the error code	41
6.2	Checking the end positions.....	43
6.3	Checking adapter ring.....	44
6.3.1	In the pressed state	44
6.3.2	In the unpressed state	44
6.4	Reading out the software version number	46
6.4.1	Examples of different versions.....	47
A	Appendix.....	49
A.1	Ordering details	49
A.2	Notes	50

1 General

The Electromotor Valve Drive ST/K 1.1 is a proportional valve drive for controlling heating valves via KNX. The bus connection is made via bus connection terminals. The valve drive lets the operator control the room thermostat easily and efficiently, which adds comfort and saves energy.

The Electromotor Valve Drive ST/K 1.1 is actuated by a continuous KNX room thermostat. The continuous actuating value permits a stepless valve position with an optimal control result. The actual valve position is indicated by five LEDs. The valve drive has two external inputs for a presence and a window contact. The status of these inputs can be sent to the KNX and used to toggle between frost protection, comfort and standby modes. Thanks to the supplied Valve Adapters, the valve drive can be used on many common thermostat valve bases. You can use the Electromotor Valve Drive ST/K 1.1 to control the function of the room thermostat. The time interval between two actuating value telegrams is monitored and an alarm telegram is triggered when the actuating value fails.

To adjust the flow temperature, the Electromotor Valve Drive ST/K 1.1 can send feedback about the current power consumption to the boiler. This can then reduce its temperature when demand is low or increase the temperature when demand is high. You can use the KNX to switch the valve drive to summer mode via a timer or a switch. In summer mode, the room thermostat's actuating valve is ignored and the valve remains closed. This prevents any heating in the morning, for example, when the desired setpoint temperature has not yet been reached.

The valve protection function prevents a stuck valve when it is not actuated for an extended period of time. When valve protection is activated, it is also executed during summer mode.

The Electromotor Valve Drive ST/K 1.1 can be actuated by a continuous room thermostat. The device is equipped with two inputs for the presence sensor and the window contact. The status of these inputs can be sent via the bus.

1.1 Using the product manual

This manual provides detailed technical information relating to the function, mounting and programming of the ABB i-bus[®] KNX Electromotor Valve Drive ST/K 1.1. The device is explained using examples.

This manual is divided into the following chapters:

Chapter 1	General
Chapter 2	Device technology
Chapter 3	Application program
Chapter 4	Commissioning
Chapter 5	Planning and application
Chapter 6	Troubleshooting
Chapter A	Appendix

1.2 Advantages

- Stepless valve position available from a continuous actuating value
- The actual valve position is displayed by five LEDs
- Emergency program available after actuating value failure (e.g. room thermostat not in operation)
- Arbitrary forced position possible via object
- Maximum actuating value can be determined
- An alarm is issued after actuating value failure
- A valve protection program is available
- An input for window contact is available
- An input for presence contact is available
- The actuating value can be limited
- Precise adjustment to any valve
- Operation is possible with both normal and inverted valves
- Construction site function is available for operation without application
- Large valve lift permits adjustment to nearly all valves
- Easy mounting with enclosed Valve Adapter

1.2.1

Notes

Notes and safety instructions are represented as follows in this manual:

Note
Tips for usage and operation

Examples
Application examples, installation examples, programming examples

Important
These safety instructions are used as soon as there is danger of a malfunction without risk of damage or injury.

Attention
These safety instructions are used as soon as there is danger of a malfunction without risk of damage or injury.

 Danger
These safety instructions are used if there is a danger to life and limb with inappropriate use.

 Danger
These safety instructions are used when there is an extreme danger to life after improper use.

1.3 Hardware versions

Two hardware versions are available: **up to 2008** and **from 2008**, with deviating features.

The version **up to 2008** (left in the picture) has two circuit boards mounted at right angles to each other.

The version **from 2008** (right in the picture) has only one printed circuit board.

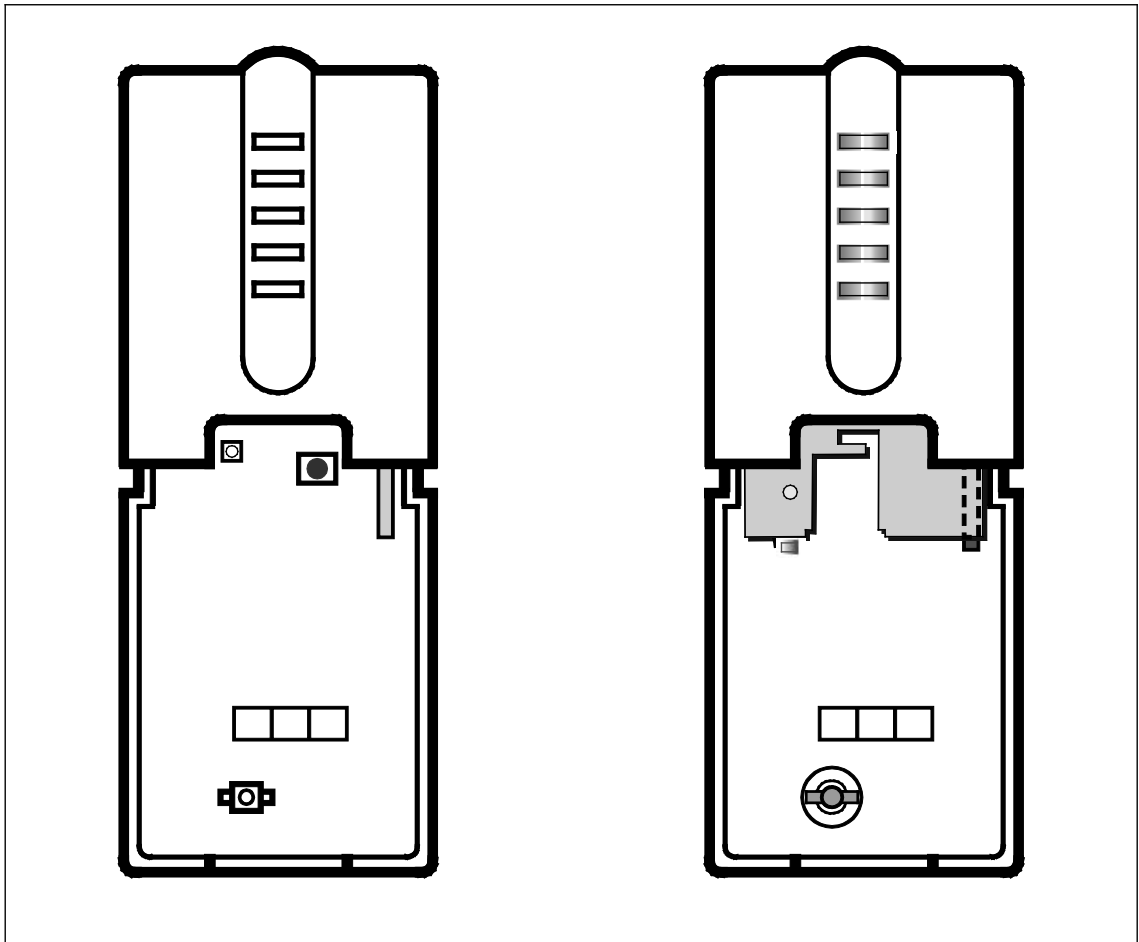

The corresponding characteristics of the versions are marked in this manual with **up to 2008** and **from 2008**.

Common software (firmware) versions:

(indicated by the LEDs), see [Reading out the software version number, p. 46](#)

Devices up to 2008	Devices from 2008
V110 V121	V44 since March 2008 V61 since May 2008

1.4 Differences

Devices up to 2008	From 2008: version V 44	From 2008: V61
<ul style="list-style-type: none"> • Only one calibration strategy • The old positions are applied (small calibration run) after the reset • Valve protection is every 24 hrs if no actuating value has changed • Construction site function always active (25% after adjustment) • Error code in \$1FB • Running light is displayed after a known error 	<ul style="list-style-type: none"> • New calibration strategy: end point via force, with preset lift • Device always performs two calibration runs and compares the results • Construction site function is definitely deleted after the first download • No more error codes • Changed LED display during calibration run • Corrective actions are initiated automatically when an error occurs 	<ul style="list-style-type: none"> • New calibration strategy: starting point as position, end point via force. • Valve protection is available only every 7 days • Calibration strategy Code stored in address in \$1FB (caution: number may look similar to previous error codes)

1.5 Possible applications

The ST/K is used in conjunction with a continuous room thermostat.

The room thermostat's (RTR) actuating value is connected to Object 0.

In this case, reduce the heating power in order to avoid any needless waste of energy when the window is open. Use window contacts for this purpose. Since the device is often installed near a window, it is recommended you use the external interface of the device. In this case, Object 5 is connected to the room thermostat's frost protection or window object. A simple solution is to connect Object 5 to Object 1. Thus, when the window is opened, the valve is moved to a previously parameterized position.

A switch for presence reporting can be connected via the second input of the external interface. In this case, Object 6 is connected to the room thermostat's comfort object.

Object 4 is controlled by a timer or a switch. A 1 on this object switches the ST/K to summer mode, i.e. the valve remains closed.

The RTR's actuating values are ignored, which prevents any heating in the morning, for example, when the desired setpoint temperature has not yet been reached.

The device can monitor the RTR's function. The ST/K regularly expects actuating value telegrams from the RTR. You can issue an alarm message via Object 7 in case these telegrams fail. This can be evaluated for maintenance purposes in a central device.

When a boiler is available with a control unit for demand-driven flow control, the Objects 3 (maximum position) of all ST/Ks and the boiler control unit's corresponding input are connected to a common group address.

1.6 Special features

Monitoring of the actuating value

The device lets you check the room thermostat's function. The time interval between two actuating value telegrams is monitored, and an alarm telegram is triggered when the actuating value fails.

Maximum actuating value (= maximum position) can be determined

To adjust the flow temperature, the ST/K can send feedback about the current power consumption to the boiler.

This can then reduce its temperature when demand is low.

Window and presence contact inputs

The device has two external inputs for a presence and a window contact. These inputs can be sent to the bus and used as a trigger for frost protection or comfort mode.

2 Device technology



The Electromotor Valve Drive ST/K 1.1 is a proportional valve drive for controlling heating valves via ABB i-bus®.

The valve drive is mounted on thermostat valve bases.

It is actuated by a continuous KNX room thermostat.

Moreover, the Electromotor Valve Drive ST/K 1.1 has two binary inputs that can be used to connect a presence contact and/or window contact, for example. The status of these inputs can be sent via the bus.

2.1 Technical data

Supply	Operating voltage	21 ... 30 V DC, is supplied via KNX	
	Current consumption		
	- motor off	5 mA	
	- motor on, seal not pressed	10 mA	
	- motor on, seal pressed	12...15 mA (depending on force)	
	Power consumption via KNX	typ. 240 mW / max. 350 mW	
Operating and display elements	Programming LED and button	To enter the physical address	
		Display of the valve position:	
		No LED:	0%
		1st LED:	1% – 20%
		2nd LED:	21% – 40%
		3rd LED:	41% – 60%
		4th LED:	61% – 80%
	5th LED:	81% – 100%	
Drive	Run time	< 20 s/mm	
	Max. controller lift	7.5 mm	
	Actuating force	max. 120 N	
	Detecting the valve stop	Fully automatic	
Connections	6-core connection line for:		
	<ul style="list-style-type: none"> • KNX (two cores) • Two binary inputs (two cores each) 	Bus connection terminal (black/red) Presence and/or window contact (yellow/green) and (white/brown)	
Degree of protection	IP 21 as per EN 60 529		
Protection class	III as per DIN VDE 0106 Part 1		
Ambient temperature range	Operation	0 °C...+50 °C	
	Storage	-20 °C...+60 °C	
	Transport	-20 °C...+60 °C	
	Medium	max. 100 °C	
Design	Compact unit for mounting on thermostat valve base		

ABB i-bus® KNX

Device technology

Housing, color	Plastic housing, white		
Mounting	On thermostat valve base	Enclosed adapter rings are suitable for:	
		<ul style="list-style-type: none"> • Danfoss RA • Heimeier • MNG • Schlösser from 3/93 • Honeywell • Braukmann 	<ul style="list-style-type: none"> • Dumser (distributor) • Reich (distributor) • Landis + Gyr • Oventrop, • Herb, • Onda
Dimensions	82.5 x 50 x 65 mm (H x W x D)		
Weight	0.2 kg		
Mounting position	any		
Approvals	EIB and KNX certified		
CE mark	in accordance with the EMC guideline and low voltage guideline		

Device type	Application program	Maximum number of group objects	Maximum number of group addresses	Maximum number of assignments
ST/K 1.1	Valve drive continuous/...*	8	18	18

* ... = current version number of the application program

ABB i-bus® KNX Device technology

2.2 Connection diagram

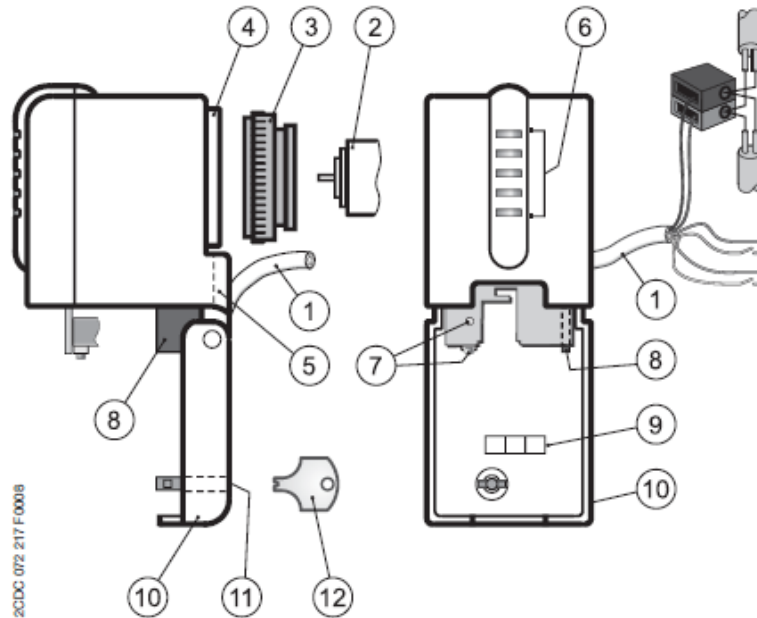

2CDC 072 217 F 0008

- | | |
|-------------------------|------------------------------|
| 1 Connection line | 7 Programming button and LED |
| 2 Thermostat valve base | 8 Disassembly lever |
| 3 Adapter ring | 9 Label carrier |
| 4 Valve connection | 10 Hinged lid |
| 5 Cable routing | 11 Lock |
| 6 Valve opening display | 12 Locking key |

2.3 Dimension drawing

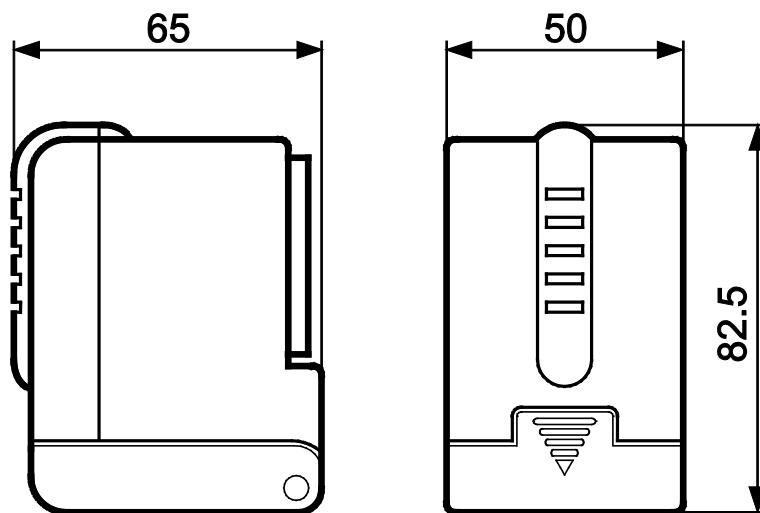

3 Application program

3.1 Selection in the product database

Manufacturer	ABB
Product family	Heating, ventilation, air conditioning
Product type	Valve drives
Program name	Valve drive continuous/1.2

You can find the ETS database on our website: <http://www.abb.com/KNX>

3.2 Parameter pages

Function	Description
Valve characteristics	Standard/user-defined valve settings and sending the valve position
Safety and forced operation	Monitoring of the actuating value, emergency program, actuating value failure, forced operation, maximum actuating value
External interface	Configuring inputs for window and presence contact
User-defined valve characteristics	Inverted valve, fine adjustment of the valve parameters, special valve characteristic curves, actuating value limitation, reaction to actuating value changes
Own valve characteristic curve	Professional parameters for valves with a known characteristic curve
Linear valve characteristic curve	Parameters for high-quality linear valves

3.3 Group objects

3.3.1 Characteristics of the group objects

No.	Function	Object name	Type	Reaction
0	Move to position	Actuating value	1 byte EIS 6	receive
1	Move to forced position	Forced position	1 bit	receive
2	Report current valve position	Current valve position	1 byte EIS 6	send
3	Determine maximum position	Maximum position	1 byte EIS 6	send and receive
4	Close valve in summer	Summer mode	1 bit	receive
5	Report window status	Window contact	1 bit	send
6	Report presence status	Presence contact	1 bit	send
7	Report actuating value failure	Actuating value failure	1 bit	send

ABB i-bus[®] KNX

Application program

3.3.2 Description of the objects

Object 0 Actuating value

Receives the actuating value specified by the room thermostat [0 ... 100%].

The valve is positioned accordingly.

Object 1 Forced position

When a 1 is sent to this object, the valve is then moved to the previously parameterized position for forced operation (see [Safety and forced operation, p. 17](#)).

The valve remains in this position until forced operation is canceled by a 0 again. The actuating value sent before or during forced operation is then approached. This position is changed only when an actuating value other than the value that is valid before forced operation is received.

This operating mode has the highest priority.

Object 2 Current valve position

Sends the actual valve position [0 ... 100%] to the bus.

This function can be enabled or disabled as required (e.g. troubleshooting).

This object is not necessary for normal operation.

Object 3 Maximum position

Depending on the parameterization, this object has the following functions:

- To receive the actuating value of the other valve drives (other rooms) in order to be able to compare them with the own actuating value and to send the own actuating value to the boiler if it is higher than the others
- To send the own actuating value to the other valve drives in order to start a new comparison

Object 4 Summer mode

A 1 on this object starts the summer mode, i.e. the actuating value is no longer considered and the valve remains closed.

When valve protection is activated, it is also executed during summer mode.

(see [Safety and forced operation, p. 17](#)).

The valve remains in the 0% position until summer mode is canceled by a 0 again.

The actuating value sent before or during summer mode is then approached. This position is changed only when an actuating value other than the value that is valid before summer mode is received.

ABB i-bus[®] KNX Application program

Object 5 *Window contact*

Sends the status of the window contact input when this is used (see [External interface, p. 37](#)).

Object 6 *Presence contact*

Sends the status of the presence contact input when this is selected (see [External interface, p. 37](#)).

Note
The window contact and the presence contact object can be linked via their group address to the room thermostat or to another object of the device (see below).

Object 7 *Actuating value failure*

Sends an alarm telegram if no new actuating value has been received from the room thermostat within a given period of time.

This object is available only when the *Monitoring of the actuating value* parameter has been activated (see parameter page [Safety and forced operation, p. 17](#), safety settings: user-defined and in the Appendix: [Monitoring of the actuating value, p. 36](#)).

Example *Window contact*:

Object 5 *Window contact* can be linked either with Object 1 *Forced position* or with the room thermostat's *Frost protection* object.

Advantage: when a window is opened for ventilation, the radiators can be throttled (previously parameterized valve position) in order to conserve heating energy.

Note
When the window input is connected to the forced position and a forced position of (or close to) 0% is selected, the radiator can freeze when the window is kept open for a long period of time

Example *Presence contact*:

Object 6 *Presence contact* can be linked to the room thermostat's *Comfort* object.

Advantage: when you enter a room where the heating is turned down, you can use a switch to set the room thermostat to comfort mode.

ABB i-bus® KNX

Application program

3.4 Parameters

3.4.1 Valve characteristics

Description	Values	Meaning
Valve settings	Default User-defined	For normal valves and applications Professional setting options
Send when changing the valve position	Do not send after a change of 1% after a change of 2% after a change of 3% after a change of 5% after a change of 7% after a change of 10% after a change of 15%	Should the new valve position be sent when it has changed compared to the last value sent? If so, from which deviation? This function is not necessary in normal operation and is mainly used for diagnostic purposes. When the specified valve position (actuating value) is reached, this is also sent if the selected change has not been reached since the last telegram (except for <i>do not send</i>).
Cyclically sending the valve position	Do not send cyclically every 2 min. every 3 min. every 5 min. every 10 min. every 15 min. every 20 min. every 30 min. every 45 min. every 60 min.	Do you want to send the current valve position cyclically? If so, at what interval?

ABB i-bus[®] KNX Application program

3.4.2 Safety and forced operation

Description	Values	Meaning
Safety settings	Default	No safety settings
	User-defined	Monitoring of the actuating value and valve protection
Monitoring of the actuating value*	Do not monitor 5 min. 10 min. 15 min. 20 min. 30 min. 45 min. 60 min.	Do you want to monitor reception of the actuating value using the room thermostat (RTR)? Recommended setting: 2 x the RTR's cycle time see Monitoring of the actuating value, p. 36 .
Valve position at actuating value failure*	0% 10% 20% 30% 40% 50% 60% 70% 80% 90% 100%	Emergency program setting. The valve moves to the position specified here during an actuating value failure. The emergency program is terminated as soon as a new actuating value is received.
Send the object Actuating value failure*	only in case of an actuating value failure Always after a monitoring cycle expires	Sent only when the emergency program is active: (value = 1) Is sent on a regular basis: in normal operation with value 0, in emergency program with value 1.
Valve position in forced operation	0% 10% 20% 30% 40% 50% 60% 70% 80% 90% 100%	Which fixed position do you want to move to when the Forced operation object is active? You can use this function when ventilating, for example.

ABB i-bus® KNX Application program

Description	Values	Meaning
Valve protection*	Active Inactive	This function prevents the valve from becoming stuck if it is not actuated for an extended period of time. The valve protection program (if active) is always executed when the actuating value has not changed in 24 hrs. The valve is thereby opened completely once and then closed again. This operation is not displayed on the LEDs.
Send the object Maximum actuating value, p. 34 (for boiler control)	Only if the own actuating value is larger every 2 min. every 3 min. every 5 min. every 10 min. every 15 min. every 20 min. every 30 min. every 45 min. every 60 min.	For all valve drives Cyclical transmission time for the individual valve drive that should trigger the actuating value comparison on a regular basis. This function is required to transmit the energy demand of the entire system to the boiler.

* Visible only for safety settings: user-defined

ABB i-bus[®] KNX Application program

3.4.3

External interface

Description	Values	Meaning
Ext. interface function	none E1: window contact, E2: none E1: window contact, E2: presence	Which external interfaces are used?
Type of connected window contact	Window open - contact closed Window open - contact open	Lets you use both NC and NO contacts.
Send the window status	Do not send cyclically every 2 min. every 3 min. every 5 min. every 10 min. every 15 min. every 20 min. every 30 min. every 45 min. every 60 min.	Do you want to send the status of the connected window contact to the bus?
Type of connected presence contact	present = contact closed present = contact open	Lets you use both NC and NO contacts.
Send the presence status	Do not send cyclically every 2 min. every 3 min. every 5 min. every 10 min. every 15 min. every 20 min. every 30 min. every 45 min. every 60 min.	Do you want to send the status of the connected presence contact to the bus?

ABB i-bus® KNX Application program

3.4.4 User-defined valve characteristics

This parameter page appears only when you select the user-defined valve settings on the *Valve characteristics* page.

The displayed parameters depend on the selected valve detection strategy.

Description	Values	Meaning
Valve control direction	Normal, closed in the pressed status	For all common valves
	Inverted, opened in the pressed status	Adaptation to inverted valves
Valve detection strategy	Default	Default detection for most valve models
	Automatic	Only for devices with software V61 and higher The valve is closed with a predefined force. The 0% position is checked each time the valve is operated and the 100% open position is measured on the valve.
	With a defined valve lift	Only for devices with software V61 and higher The 0% position is checked each time the valve is operated and the 100% (open) position is determined from the set lift.

ABB i-bus[®] KNX Application program

Description	Values	Meaning
Strategy = Default		
Added sealing pressure of the rubber seal in 1/100 mm	0..79 (default = 20)	<p>The set value determines the added sealing pressure in 1/100 mm.</p> <p>This presses the valve shut further by a specified distance if it does not close one hundred percent due to the properties of the rubber seal.</p> <p>Caution: To avoid damaging the seal, the value should be increased by a maximum of 10 increments.</p> <p>Setting: 1 corresponds to 1/100 mm 10 corresponds to 0.1 mm 20 corresponds to 0.2 mm etc. (see Valves and valve seals, p. 34)</p>
Strategy = Automatic (from SW V61)		
Closing force for	Normal valves Valves with a high spring force	This parameter determines the closing force for the 0% position.
Strategy = with a defined valve lift (from SW V61)		
Closing force for	Normal valves Valves with a high spring force	See above
Valve lift	2 mm, 3 mm, 4 mm, 5 mm, 6 mm	Travel from the 0% to the 100% position is set manually here.

ABB i-bus® KNX Application program

Description	Values	Meaning
Valve seal type	Standard valve seal Valve with a hard seal Valve with a soft seal Valve with a semi-soft seal	This parameter should be changed only when the valve does not open at low actuating values. (see Troubleshooting, p. 39)
Valve characteristic curve	Typical characteristic curve Own characteristic curve Linear characteristic curve	For all common valve types For special valves with a known characteristic curve For high-quality valves
Min. actuating value	0% 5% 10% 15% 20% 25% 30% 40%	Lowest valve position that is approached This parameter prevents the valve from whistling at a too low flow rate.
Reaction when the minimum actuating value is not achieved	0% 0% = 0% otherwise min. actuating value:	It should be set to 0% for each actuating value that is below Minimum value. Each actuating value that is below the minimum value is moved to the position of the previously set minimum actuating value. The valve is completely closed only when the actuating value is at 0%.
Maximum actuating value	60% 70% 75% 80% 85% 90% 95% 100%	Highest valve position that is approached Tip: Since most valves do not change their flow between 60% and 100%, the positioning frequency can be reduced by specifying a maximum actuating value of 60%.
Moving to the new valve position	always position accurately after changing the actuating val. >1% after changing the actuating val. >2% after changing the actuating val. >3% after changing the actuating val. >5% after changing the actuating val. >7% after changing the actuating val. >10% after changing the actuating val. >15%	The valve is repositioned every time the actuating value is changed The valve is always repositioned only when the actuating value has changed by more than the set value compared to the last positioning. Frequent, small positioning steps can thus be suppressed Important: Too high a value can impair temperature control.

ABB i-bus[®] KNX Application program

3.4.5

Own valve characteristic curve

Professional setting for special valves

This parameter page appears only when the own valve characteristic curve has been selected on the *Device settings* page.

The control valve's reaction can be precisely adjusted here based on the valve's characteristic curve (manufacturer's documentation).

This parameter lets you adjust the ST/K to a valve over nine points of the characteristic curve [10% ... 90%]. Each point determines at what % of valve lift a certain flow rate is achieved.

Description	Values	Meaning
Valve lift in % for a 10% flow rate [1 ... 99]	1...99 (10)	At what % of valve lift is a flow rate of 10% achieved?
Valve lift in % for a 20% flow rate [1 ... 99]	1...99 (20)	At what % of valve lift is a flow rate of 20% achieved?
Valve lift in % for a 30% flow rate [1 ... 99]	1...99 (30)	At what % of valve lift is a flow rate of 30% achieved?
Valve lift in % for a 40% flow rate [1 ... 99]	1...99 (40)	At what % of valve lift is a flow rate of 40% achieved?
Valve lift in % for a 50% flow rate [1 ... 99]	1...99 (50)	At what % of valve lift is a flow rate of 50% achieved?
Valve lift in % for a 60% flow rate [1 ... 99]	1...99 (60)	At what % of valve lift is a flow rate of 60% achieved?
Valve lift in % for a 70% flow rate [1 ... 99]	1...99 (70)	At what % of valve lift is a flow rate of 70% achieved?
Valve lift in % for a 80% flow rate [1 ... 99]	1...99 (80)	At what % of valve lift is a flow rate of 80% achieved?
Valve lift in % for a 90% flow rate [1 ... 99]	1...99 (90)	At what % of valve lift is a flow rate of 90% achieved?

The values in brackets represent a linear valve.

ABB i-bus® KNX Application program

Diagram 1 displays a valve characteristic curve that occurs frequently in practice.

A flow rate of 30% is already available at a 10% valve lift in this characteristic curve. The flow rate is over 80% at a 50% valve lift.

Diagram 1

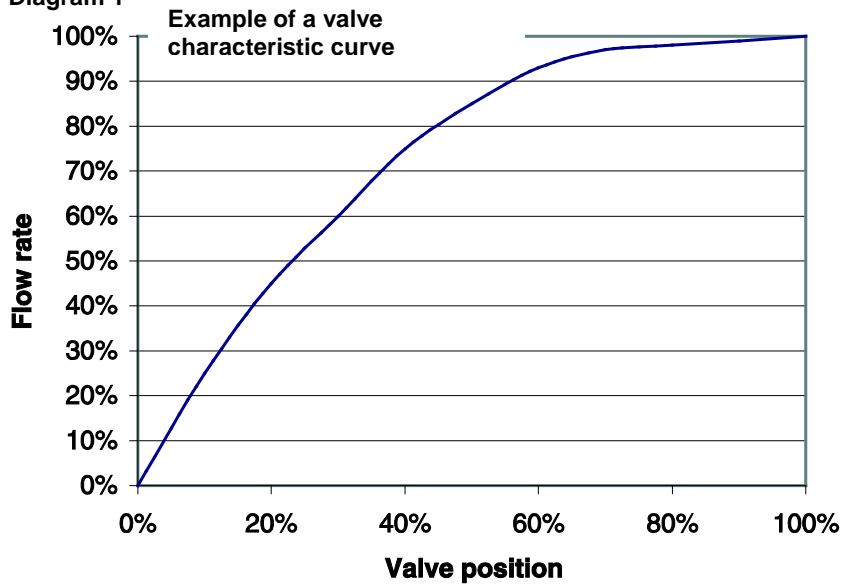

A linear characteristic curve as depicted in Diagram 2 would be ideal for control.

Entering an own characteristic curve can linearize a nonlinear characteristic curve.

To do this, the valve positions (lift) at a 10, 20 ... 90% flow would have to be obtained from Diagram 1 and entered into the *Own characteristic curve* parameter page.

Diagram 2



ABB i-bus[®] KNX Application program

3.4.6 Linear valve characteristic curve

This setting should solely be used for valves that are expressly marked as linear.

Note: The values are only displayed in this table and cannot be changed

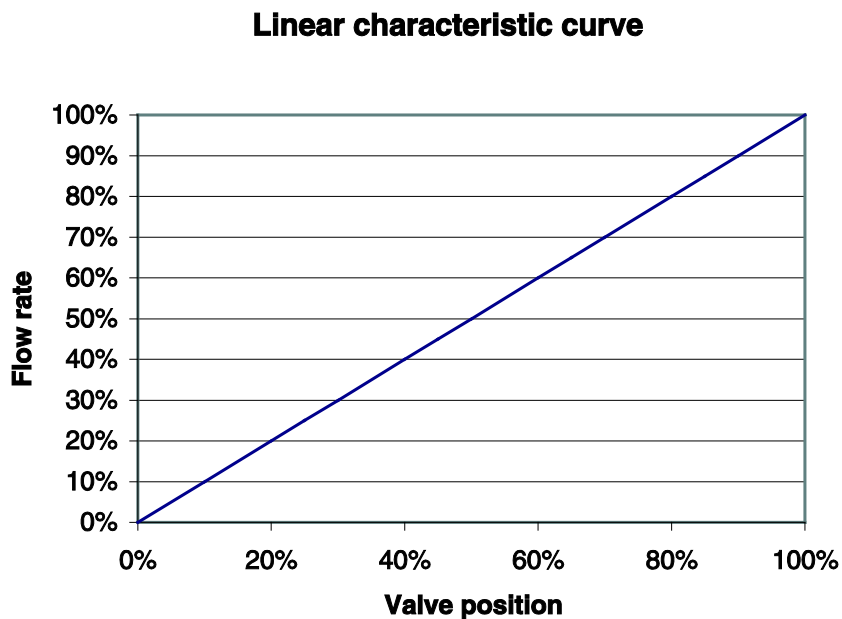
Description	Values	Meaning
Valve lift in % for a 10% flow rate [1 ... 99]	10	A flow rate of 10% is achieved at a 10% valve lift, while 20% is achieved at a 20% valve lift, etc.
Valve lift in % for a 20% flow rate [1 ... 99]	20	
Valve lift in % for a 30% flow rate [1 ... 99]	30	
Valve lift in % for a 40% flow rate [1 ... 99]	40	
Valve lift in % for a 50% flow rate [1 ... 99]	50	
Valve lift in % for a 60% flow rate [1 ... 99]	60	
Valve lift in % for a 70% flow rate [1 ... 99]	70	
Valve lift in % for a 80% flow rate [1 ... 99]	80	
Valve lift in % for a 90% flow rate [1 ... 99]	90	

4 Commissioning

Attention

Always remove the valve drive when servicing the radiator; securely close the valve (original protective cap).
The valve could be opened unexpectedly by the controller or by the valve protection, thus resulting in water damage.

Important

The device must already be mounted on the valve when downloading the application, otherwise it cannot be adapted.

4.1 Installation

1. The device with the corresponding adapter ring is attached to the valve first.
2. The bus voltage can then be applied.

This automatically starts adaptation (calibration run).

Since the valve tappet's travel (lift) between 0% (valve fully closed) and 100% (valve fully open) can be very different from valve to valve, the Electromotor Valve Drive ST/K 1.1 automatically adapts itself to the existing valve.

Automatic adaptation (calibration run)

- The valve drive first retracts its spindle completely (0% - valve closed). The 1st LED flashes.
- The spindle advances until the valve tappet is touched (100% - valve is open to the maximum). The 2nd LED flashes.
- The spindle presses the tappet until the seal is pressed into the seat (0% - valve closed). The 3rd LED flashes.

This can take several minutes. The Electromotor Valve Drive ST/K 1.1 is subsequently precisely adapted to the existing valve, moves to 25% open position and the 2nd LED lights up.

Both end positions (0% and 100%) are stored and remain unchanged even after a power failure/reset. They act as fixed reference points for positioning.

When does adaptation take place?

Automatic adaptation is performed for the first time after the bus voltage has been applied in the construction site function, otherwise after each download of the application.

A new calibration run is carried out after a reset and at regular intervals during the heating period.

The valve is automatically checked at regular intervals in order to compensate for changes in the valve characteristics over time (aging of the rubber seal).

Important

- If an already adapted device is plugged onto another valve, then adaptation is required again by downloading the application.
- The previously stored positions are deleted after a download. The calibration run is conducted twice because of the plausibility check.

4.2 Calibration strategies

Two additional calibration strategies were introduced as of the V61 software.

The objective of the calibration strategies is to adapt to the largest possible number of different valves.

The calibration strategy is selected by making an entry in the *Strategy for valve detection* parameter.

4.2.1 Strategy 1, default

During the calibration run (e.g. after a reset), the valve is measured and the position for *Valve open* and *Valve closed* is stored. After the download, the calibration run is performed twice and the ascertained values are checked for plausibility. If the values do not match, the calibration run is repeated until two successive pairs of values are plausible. These values are then stored and used for the subsequent runs to the positions. During the calibration run, the ascertained values are compared with the previously stored values so that the procedure only takes place once for plausibility.

ABB i-bus[®] KNX Commissioning

4.2.2 Strategy 2, automatic (only for devices from software version 61)

In this variant, only the Open position of the valve is determined during the calibration run. In order to close the valve, the valve drive moves the tappet until it presses on the valve with the set force. The following closing forces are adjustable:

Closing force for	Closing force
Normal valves	approx. 100 N
Valves with a high spring force	approx. 120 N

It is recommended to only use the *normal valves* setting first. This is completely sufficient for most valves.

Only when you cannot close the valve with this setting should you try the *valves with high spring force* setting. This can increase current consumption up to 15 mA while the rubber seal is being pressed.

4.2.3 Strategy 3, with defined valve lift (only for devices from software version 61)

With this variant, only the valve's open position is determined by recalculating a fixed path from the closed position. In order to close the valve, the valve drive extends the tappet until it presses on the valve with the set force *Closing force for normal valves/Valves with a high closing force*.

Use this calibration strategy especially when the valve drive's tappet – even when it is pulled all the way inwards – touches the valve tappet and thus prevents any measurement.

The value **3 mm** with *Closing force for normal valves* is a useful initial value for a completely unknown valve.

It is recommended to use the *Closing force for normal valves* setting first.

This setting is completely sufficient for most valves.

Only when you cannot use this setting to close the valve should you try the setting for *Valves with a high spring force*. This can increase current consumption up to 15 mA while the rubber seal is being pressed.

The running light is displayed when this calibration method fails even after three attempts.

ABB i-bus[®] KNX Commissioning

4.2.4

LED display during calibration run

LEDs	Devices up to 2008	Devices from 2008
<div style="display: flex; flex-direction: column; align-items: center;"> <div style="border: 1px solid black; width: 100px; height: 20px; margin-bottom: 2px; text-align: center;">4</div> <div style="border: 1px solid black; width: 100px; height: 20px; margin-bottom: 2px; text-align: center;">3</div> <div style="border: 1px solid black; width: 100px; height: 20px; margin-bottom: 2px; text-align: center;">2</div> <div style="border: 1px solid black; width: 100px; height: 20px; margin-bottom: 2px; text-align: center;">1</div> <div style="border: 1px solid black; width: 100px; height: 20px; margin-bottom: 2px; text-align: center; background-color: red;">0</div> </div>	Flashes until the spindle is in the maximum inner position	
<div style="display: flex; flex-direction: column; align-items: center;"> <div style="border: 1px solid black; width: 100px; height: 20px; margin-bottom: 2px; text-align: center;">4</div> <div style="border: 1px solid black; width: 100px; height: 20px; margin-bottom: 2px; text-align: center;">3</div> <div style="border: 1px solid black; width: 100px; height: 20px; margin-bottom: 2px; text-align: center;">2</div> <div style="border: 1px solid black; width: 100px; height: 20px; margin-bottom: 2px; text-align: center; background-color: red;">1</div> <div style="border: 1px solid black; width: 100px; height: 20px; margin-bottom: 2px; text-align: center;">0</div> </div>	Flashes until the 100% position has been found	Flashes while the valve is being scanned
<div style="display: flex; flex-direction: column; align-items: center;"> <div style="border: 1px solid black; width: 100px; height: 20px; margin-bottom: 2px; text-align: center;">4</div> <div style="border: 1px solid black; width: 100px; height: 20px; margin-bottom: 2px; text-align: center;">3</div> <div style="border: 1px solid black; width: 100px; height: 20px; margin-bottom: 2px; text-align: center; background-color: red;">2</div> <div style="border: 1px solid black; width: 100px; height: 20px; margin-bottom: 2px; text-align: center;">1</div> <div style="border: 1px solid black; width: 100px; height: 20px; margin-bottom: 2px; text-align: center;">0</div> </div>	Flashes until the 0% position has been found	Flashes during position calculation (can be very short)

4.3 Construction site function

The device works in construction site mode as long as the device is in the factory default setting, i.e. as long as no application has been loaded.

This causes the valve to be opened to 25% in order to prevent the radiator from freezing.

Thanks to this function, the device is **immediately ready for use at the construction site with limited function**.

The construction site function is definitely deleted after downloading the application software.

After the reset, the ST/K accepts a preset position from this point in time and as long as no actuating value is received.

Up to 2008: ST/K opens the valve to 25%.

From 2008: ST/K closes the valve completely.

You can find the ETS database on our download page: <http://www.abb.com/KNX>

4.4 Checking the 0% position

After putting it into service and successful adaptation, it is recommended to check the device on a radiator to make sure that the valve closes properly.

To do this, you must wait until the radiator, which has warmed up during the calibration run, has cooled down completely.

Depending on the flow temperature, this can take some time.

Please make sure that no actuating value > 0% is sent to the ST/K during this time. As a precaution, forced operation can be activated at 0% or summer mode can be activated.

ABB i-bus® KNX Planning and application

5 Planning and application

5.1 Valves and valve seals

5.1.1 Valve design



ABB i-bus® KNX

Planning and application

5.1.2 Valves and valve seals

At rest, i.e. when the tappet is not actuated, the spring pushes the tappet outwards and the valve is open (100% position for normal control direction).

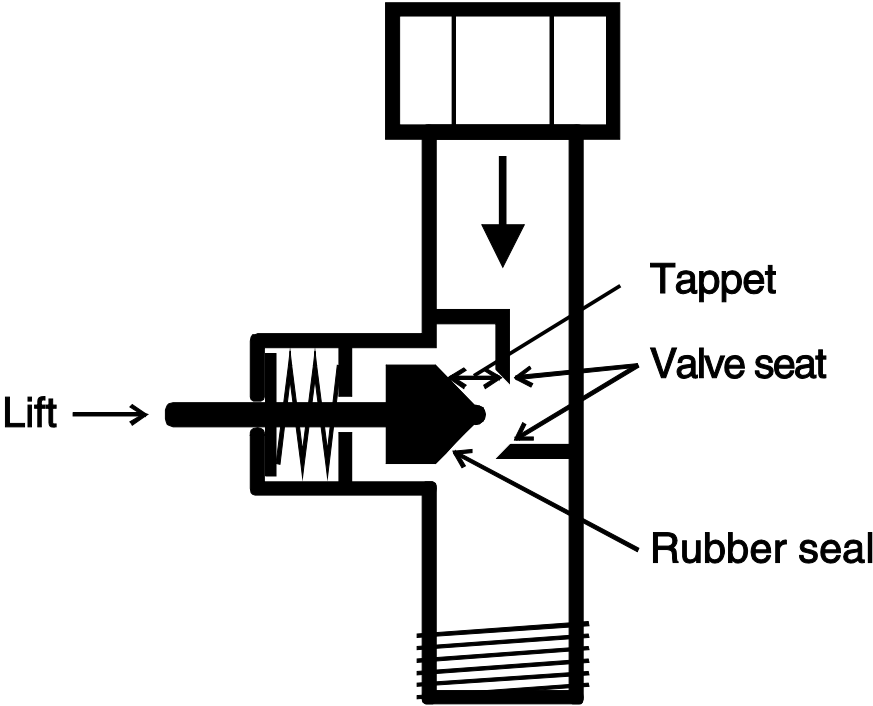
When the tappet is pressed, the rubber seal is pressed into the valve seat and the valve is closed (0% position for normal control direction).

The valve does not close immediately when the rubber seal touches the valve seat. In some circumstances and depending on the characteristics of the seal, the tappet must continue moving several 1/10 mm until the valve is really closed.

This reaction is determined by the hardness, shape, aging or damage to the valve seal.

Attention

Increase the value in maximum increments of 10 to avoid damaging the seal.

In order to correct the influence of these parameters, you can enter added sealing pressure of the valve seal (see also [Troubleshooting, p. 39](#)).

5.2 Limiting the actuating value

The ST/K receives its actuating value [0 ... 100%] from the room thermostat. In most cases it is not necessary to use the entire bandwidth between 0% and 100%.

5.2.1 Maximum actuating value

With many valves, the flow rate between the 60% and 100% actuating value no longer changes in the upper range. This means that the radiator already heats up at its maximum power at an actuating value of 60%.

Readjustment of the valve drive in the upper range could therefore be suppressed without any adverse effects, and this could significantly reduce the positioning frequency.

ABB i-bus[®] KNX

Planning and application

5.2.2 Min. actuating value

You can avoid the annoying whistling noise that some valves create at a low actuating value by defining a minimum actuating value (see [User-defined valve characteristics, p. 20](#)).

If you detect this reaction at an actuating value below 8%, you can then define a minimum actuating value of 10%.

When an actuating value is received below the defined limit value, the device can react in two different ways (*reaction when the minimum actuating value is not reached*):

- Move immediately to 0% (0%)
- Remain at the position of the minimum actuating value and then close the valve completely (0% = 0%, otherwise minimum actuating value) when the actuating value of 0% is received.

5.3 Determining the max. actuating value

5.3.1 Application

If the valve drives are only slightly open in a system, e.g. one at 5%, one at 12%, and another at 7%, etc., the boiler can then reduce its output because only little heating energy is needed.

In order to ensure this, the boiler needs the following information:

How large is the actuating value in the room that currently has the greatest heat demand?

Exactly this task is performed by the *Determine maximum position* function in the ST/K.

5.3.2 Principle

The actuating values are constantly compared among all devices (ST/K drive valves). The devices with a larger actuating value than the received value may send this value; the devices with the smaller value do not send.

In order to speed up the process, a valve drive sends the values faster the greater the difference between the own value and the received actuating value is.

This way, the valve drive with the greatest actuating value is the first to send values and overrides all others.

ABB i-bus® KNX

Planning and application

5.3.3 Practical application

The actuating values are compared via object 3 (*maximum position*).

A common group address for the maximum position is thereby assigned to object 3 for each valve drive.

To start comparing actuating values among the devices, one (and only one) must cyclically send a value to this group address.

Either the boiler or one of the valve drives can perform this task.

If it is the boiler, then it must have the smallest possible value, i.e. send 0%.

If it is one of the ST/K valve drives, then you must set the *Send the object Maximum actuating value (for boiler control)* parameter to an arbitrary cycle time on the *Safety and forced operation* parameter page. This valve drive then regularly transmits its own actuating value and the other drives can react to it.

Regardless which device acts as the trigger, you must set the *Send the maximum actuating value (for boiler control)* parameter for all other valve drives to the *only if own actuating value is higher* default value.

5.4 Monitoring of the actuating value

5.4.1 Application

If the room thermostat (RTR) fails while the last actuating value was 0%, then all valves remain closed regardless of the continued temperature profile in the room. This can lead to considerable damage if cold air penetrates the room at ambient temperatures below zero, for example.

In order to prevent this, the device can perform the following functions:

- monitor the room thermostat function
- start the emergency program after actuating value failure
- send status of actuating value monitoring

5.4.2 Principle

The ST/K monitors if at least one actuating value telegram is received within the parameterized time value and adopts a predefined position in case of an actuating value failure

ABB i-bus[®] KNX

Planning and application

5.4.3 Practical application

The RTR is parameterized to cyclically send the actuating value.

The monitoring time is set to a value in the ST/K that is at least twice as long as the RTR's cycle time.

In this case, the monitoring time must be at least 20 minutes when the RTR transmits its actuating value every 10 minutes.

After actuating value failure, normal operation is resumed as soon as a new actuating value is received.

5.5 External interface

The external interface consists of the inputs E1 and E2.

Both inputs are led out via the connection line on the device.

The inputs are parameterized on the parameter page [External interface, p. 19](#).

The current status of both inputs is sent to the bus based on the parameterization and can thus be evaluated by other devices (room thermostat, etc.).

5.5.1 Connections

Name	Color	Function
BUS	Black (-)	KNX bus line
	Red (+)	
E1	Yellow	Binary input for window contact(s)
	Green	
E2	White	Binary input for presence detector or presence sensor
	Brown	

5.5.2 Input E1

E1 is used for window contacts (if available).

The window contacts can be connected directly and without additional power supply.

5.5.3 Input E2

A presence detector or pushbutton can be connected directly here

6 Troubleshooting

Attention: error codes are available only in the version up to 2008.

Reaction	Error code	Possible cause	Remedy
All LEDs are flashing as a running light from bottom to top, i.e. valve adaptation was not successful.	82	no valve	Connect the device to the valve and reload the application
	84	Valve tappet is already touched even though the valve drive spindle is fully retracted.	Use a different Valve Adapter. Please contact our customer service. The valve tappet must be at least 3/10 mm from the spindle when the spindle is fully retracted (see below, Check adapter ring, p. 44).
	81	Valve tappet cannot move at the maximum force (120 N) either.	Check if the tappet is stuck. If so, replace valve.
	81	After being putting into service, the valve drive was attached to another valve and must be adapted again.	Download the application again. The valve drive is then adapted automatically.
	81	Valve seal is pressed in too firmly.	Cancel added sealing pressure of the rubber seal
	83	Valve is stuck	Check valve

ABB i-bus® KNX Troubleshooting

Reaction	Possible cause	Remedy
Valve does not close at 0% actuating value	Valve seal is not pressed firmly enough onto the valve seat	Enter added sealing pressure of the rubber seal Caution: increase the parameter in increments of no more than 10 or, (from 2008) Select another Calibration strategy
	Valve seal is damaged	Replace valve
Valve opens only with an unexpectedly large actuating value	Existing valve seal is too soft	Adjust the parameter Valve seal type If the valve opens only at actuating values over: 5% ⇒ select standard valve seal 10% ⇒ select medium soft seal 20% ⇒ select soft seal
Valve does not move to actuating values below or above a certain value	The Minimum or maximum actuating value parameter(s) has been/were changed	Check the parameter for the minimum or maximum actuating value
No display or no calibration run after a reset	ST/K was unloaded with the ETS software	Reprogram the device: Phys. address + application
Error message with ETS query/device info: Execution state → is not running	ST/K was unloaded with the ETS software	Reprogram the device: Phys. address + application

ABB i-bus[®] KNX Troubleshooting

6.1 Reading out the error code

IMPORTANT: the error code was replaced in 2008 by the code for the calibration strategy.

Up to 2008:

The ST/K generates an error code when the valve triggers an error message and the LEDs flash as a running light.

This is contained in the BCU memory and can be read out (commissioning/test) using the ETS software as follows:

1. Select the device in the project and click on the Test / Device Memory Viewer... item

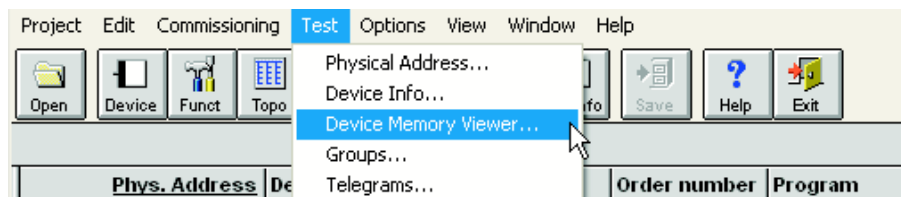

2. Enter 1FB under "Define Address Area", deselect RAM and EEPROM

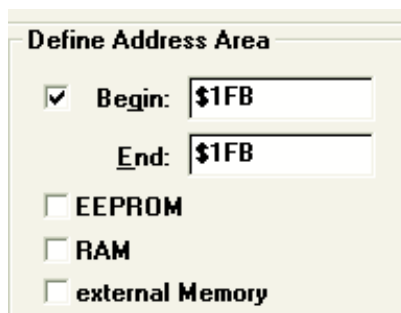

3. Press the  button.

ABB i-bus® KNX Troubleshooting

- The error code appears in the results window

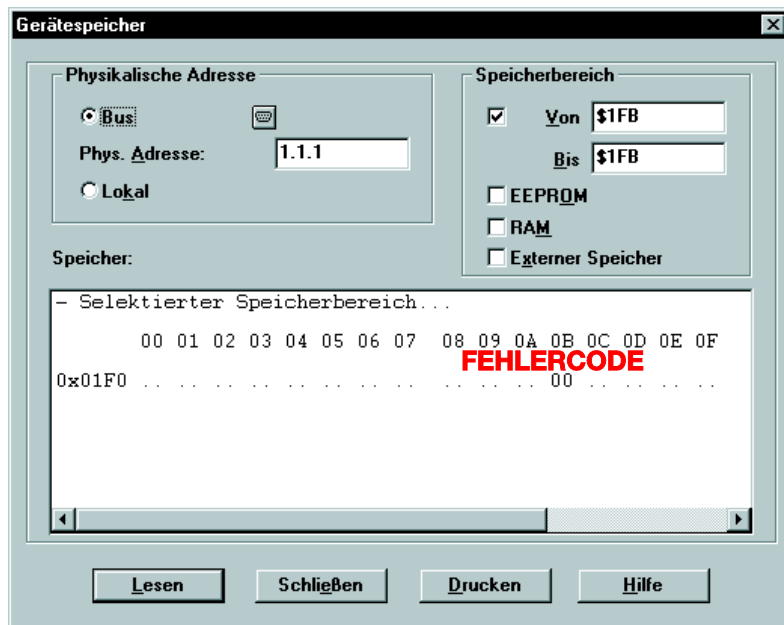

Code	Name
00	No fault
81	Overcurrent shutdown
82	Valve not found
83	Valve does not move
84	Lift is too short

6.2 Checking the end positions

The end positions stored during adaptation can be read out just like the error numbers by using the ETS software.

The inner stop position (spindle retracted, valve open) is stored under the address \$1FC and the outer one under \$1FD in the hex format.

These values are reset (i.e. \$1FC = 00 and \$1FD = FF) after downloading the application.

The detected stop positions are entered there after the application has been successfully adapted.

This adaptation was not successful when 00 is displayed in both addresses after the adaptation.

In order to determine the stop positions in millimeters, the values are converted into decimal numbers and divided by 20.

Sample calculation:

Position	Valve	Address	Hexadecimal value	Corresponds to decimal value	Result decimal value/20 =
Inside stop	open	\$1FC	24	36	1.8 mm
Outside stop	closed	\$1FD	61	97	4.85 mm

The lift is calculated from the two values as follows:

Lift = outer stop – inner stop

In our example:

Lift = 4.85 mm – 1.8 mm = 3.05 mm

Limit values for successful adaptation

The following values must be maintained:

Inside stop		Outside stop		Lift	
Dimension	Hex value	Dimension	Hex value	Dimension	Hex value
≥ 0.3 mm	≥ 6	≤ 7.5 mm	≤ 96	≥ 1.2 mm	≥ 18

6.3 Checking adapter ring

6.3.1 In the pressed state

Before and after 2008:

The distance between the upper edge of the adapter and the upper edge of the tappet in the pressed state must not exceed 2.7 mm.

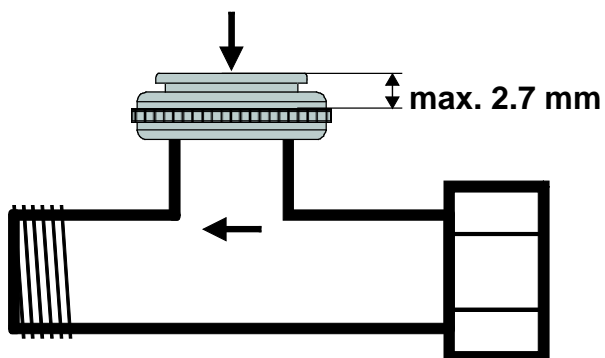

6.3.2 In the unpressed state

Up to 2008:

The maximum distance between the upper edge of the adapter ring and the end of the tappet is 4.7 mm.

You must use a different adapter ring if this dimension is exceeded.

From 2008:

You can use all calibration strategies for a dimension up to max. 4.7 mm.



ABB i-bus[®] KNX Troubleshooting

From 2008:

A dimension of up to 7 mm is possible when the 3rd calibration strategy is used.

Attention: the valve cannot be opened 100% when the dimension is > 4.7 mm. This is not relevant in most cases since the flow of many valves is already sufficient when half open.

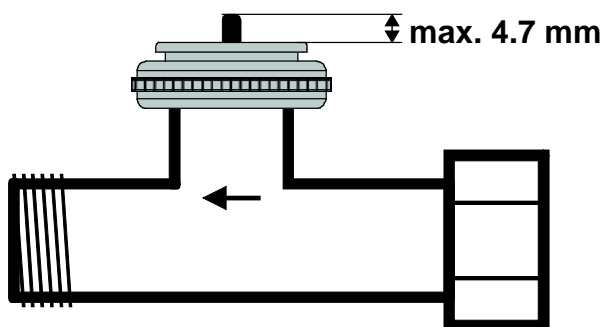
Only a lift up to 4.7 mm is usable. You must therefore estimate whether the Valve Adapter is appropriate while taking the remaining lift and the valve characteristic curve into account.

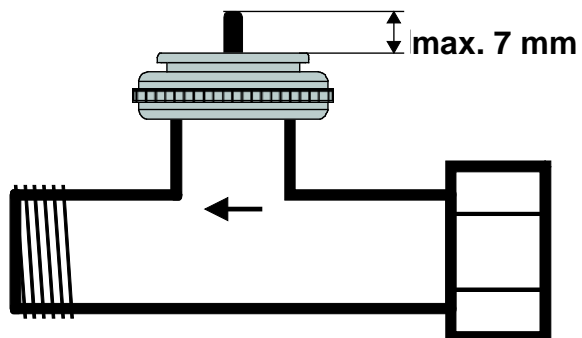

6.4 Reading out the software version number

The device displays the current software version with the LEDs.

This is displayed after a reset as a binary number in three stages.

1st stage: full display: All LEDs = ON

2nd stage: LED 0 is ON and the upper four bits are output (= Hi nibble, value: see table)

3rd stage: LED 0 is ON and the lower four bits are displayed (= Lo nibble).

The value of the individual LEDs can be read as follows:

LEDs	Value
4	8 (= 23)
3	4 (= 22)
2	2 (= 21)
1	1 (= 20)
0	none

The number in each case results from the sum of the values of the illuminated LEDs 1 ... 4.

LED 0 is not considered.

ABB i-bus® KNX Troubleshooting

6.4.1

Examples of different versions



































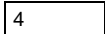
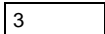

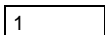

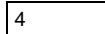
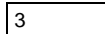



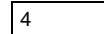
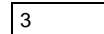



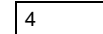

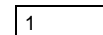

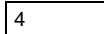





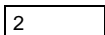
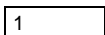



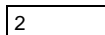





Devices from 2008			Devices up to 2008	
Example 1 Version 044 = \$2C (one printed circuit board)	Example 2 Version 061 = \$3D (one printed circuit board)	Example 3 Version 063 = \$3F (one printed circuit board)	Example 4 Version 110 = \$6E (two printed circuit boards)	Example 5 Version 121 = \$79 (two printed circuit boards)
1st stage = All LEDs ON				
    	    	    	    	    
2nd stage = Hi nibble				
    	    	    	    	    
3rd stage = Lo nibble				
    	    	    	    	    
00101100 = \$2C	00111101 = \$3D	00111111 = \$3F	01101110 = \$6E	01111001 = \$79

ABB i-bus[®] KNX Appendix

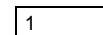
A Appendix

A.1 Ordering details

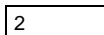
Device type	Product Name	Order No.	bbn 40 16779 EAN	Price group	Weight 1 pcs. [kg]	Packaging [pcs.]
ST/K 1.1	Electromotor Valve Drive	2CDG 120 004 R0011	63022 1	P3	0.2	1

ABB i-bus[®] KNX Appendix

A.2 Notes

ABB i-bus[®] KNX Appendix

Notes

ABB i-bus[®] KNX Appendix

Notes

Contact us

ABB STOTZ-KONTAKT GmbH

Eppelheimer Strasse 82

69123 Heidelberg, Germany

Phone: +49 (0)6221 701 607 (Marketing)

+49 (0)6221 701 434 (KNX Helpline)

Fax: +49 (0)6221 701 724

e-mail: knx.marketing@de.abb.com

knx.helpline@de.abb.com

For additional information and local contacts:

www.abb.com/knx

Note:

We reserve the right to make technical changes or modify the contents of this document without prior notice.

The agreed properties are definitive for any orders placed. ABB AG does not accept any responsibility whatsoever for potential errors or possible lack of information in this document.

We reserve all rights in the Document and in the subject matter and illustrations contained therein. Reproduction, transfer to third parties or processing of the content – including sections thereof – is not permitted without prior expressed written permission from ABB AG.

Copyright© 2016 ABB

All rights reserved

Publication number 2CDC 508 025 D0203 (12.16)