

ABB i-bus® EIB / KNX
Shutter Control Unit, MDRC
JSB/S 1.1

Intelligent Installation Systems



Content

	Page
1	Introduction 3
2	Device technology 4
3	Application and planning
3.1	Tracking the position of the sun 7
3.1.1	Shutter control system that tracks the position of the sun 7
3.1.2	Setting up a shutter control system that tracks the position of the sun 8
3.1.3	Planning notes 9
3.2	Position of the sun 10
3.2.1	Position of the sun as a controlled variable 10
3.2.2	Calculating the position of the sun 11
3.2.3	Measuring the brightness 13
3.2.4	Delay periods and intermediate position 14
3.3	Geometry of the louvres 15
3.3.1	Horizontal louvres/vertical louvres 15
3.3.2	Horizontal louvres with light redirection 17
3.4	Casting shadows 18
3.4.1	Introduction 18
3.4.2	Windows/groups of windows 19
3.4.3	Shadow objects 21
3.4.4	Planning example: Division of façades 23
3.4.5	Planning example: Shadow objects 28
4	Project design and programming
4.1	Parameters 30
4.1.1	Parameter window: “General” 30
4.1.2	Parameter window: “Date/time” 32
4.1.3	Parameter window: “Summer/winter 1/2” or “Summer/winter 3/4” 34
4.1.4	Parameter window: “Sensors” 35
4.1.5	Parameter window: “Send” 36
4.1.6	Parameter window: “Height” 37
4.1.7	Parameter window: “Intermediate position” 38
4.1.8	Parameter window: “Horizontal louvres” 39
4.1.9	Parameter window: “Vertical louvres” 41
4.1.10	Parameter window: “Building data” 42
4.1.11	Parameter window: “Façade A” 43
4.1.12	Parameter window: “A: Grid system” 44
4.1.13	Parameter window: “A: Groups” 45
4.1.14	Parameter window: “Shadows 1–10” or “Shadows 11–20” 46
4.1.15	Parameter window: “Shadow 1” 47
4.2	Communication objects 49
4.2.1	“Input” communication objects 49
4.2.2	“Output” communication objects 49
4.2.3	“Date/time” communication objects 51
5	Appendix
5.1	Time zones 52
5.2	Planning checklist 54
5.3	Ordering information 58

1 Introduction

Who isn't familiar with this scenario? The cloud lifts, the sun is shining brighter and brighter and suddenly you can no longer see anything on your screen. You have hardly had a chance to position the shutter accordingly when the sun disappears behind the next black cloud and it is dark at your desk again.

The position of the sun changes constantly and the louvres must always be manually adjusted so that the sun does not dazzle you but yet the shutter does not darken the room completely.

The automatic sun protection system provides help for this situation. Brightness sensors permanently detect the lighting conditions and the shutter control module always calculates the current position of the sun. In accordance with the required individual settings, the shutter actuator is controlled so that optimum use is always made of the daylight conditions.

Whether you require anti-glare protection or daylight redirection, the shutter control module JSB/S 1.1 is the suitable control unit for your shutter control system.

The calculated position of the sun is combined logically in the shutter control module JSB/S 1.1 with a threshold value for the sunlight, so that the shutter is only moved into the calculated position when the sun is actually shining.

Up to 4 façades can be controlled separately per shutter control module. If more than 4 façades need to be controlled (e.g. if there are several building sections), several shutter control modules can simply be operated next to each other in parallel.

The influence of shadows e.g. trees or the building opposite is taken into account. Up to 20 shadow objects can be parameterised and up to 200 windows (4 façades with 50 windows) can be controlled individually.

The geometrical data for the louvres, façades, windows (window groups) and shadow objects is set via the parameters. Each façade can be operated either with vertical or horizontal louvres or louvres with light redirection.

2 Device technology

Product and functional overview



The shutter control module controls shutter actuators with the functions of anti-glare protection and daylight redirection via the ABB i-bus® EIB. The current position of the sun is always calculated and logically combined with a threshold value for the sun's intensity so that the shutter is only moved into the calculated position when the sun is actually shining.

The influence of shadows (e.g. the building opposite) is taken into account. Up to 200 windows or groups of windows can be controlled individually. The geometrical data for the louvres, façades, windows (window groups) and shadow objects is set via the parameters. Each of up to 4 façades can be operated either with vertical or horizontal louvres or louvres with light redirection.

Technical data

Power supply	– Operating voltage	21...30 V DC, via the EIB
	– Power consumption	typ. 10 mA
	– Leakage loss	max. 300 mW
Operating and display elements	– Red LED and push button	For entering the physical address
Internal clock	– Accuracy	max. +/- 1 second/day at + 25 ... + 30 °C max. +/- 2,5 seconds/day at – 5 ... + 45 °C
	– Reserve power	min. 1 hour typ. 12 ... 24 hours
	Connections	– EIB
Type of protection	– IP 20, EN 60 529	
Ambient temperature range	– Operation	– 5 °C ... + 45 °C
	– Storage	– 25 °C ... + 55 °C
	– Transport	– 25 °C ... + 70 °C
Design	– Modular installation device, proM	
Housing, colour	– Plastic housing, grey	
Installation	– on 35 mm mounting rail, DIN EN 60 715	
Dimensions	– 90 x 36 x 64 mm (H x W x D)	
Mounting depth/width	– 68 mm/ 2 modules at 18 mm	
Weight	– 0.07 kg	
Mounting position	– Any	
Certification	– EIB- and KNX-certified	
CE norm	– in accordance with the EMC guideline and the low voltage guideline	

Shutter Control Unit, MDRC

Application program: Shutter Control /1

JSB/S 1.1, GH Q631 0084 R0111

Application programs

	Number of communication objects	Max. number of group addresses	Max. number of associations
Shutter Control /1	224	254	255

Circuit diagram

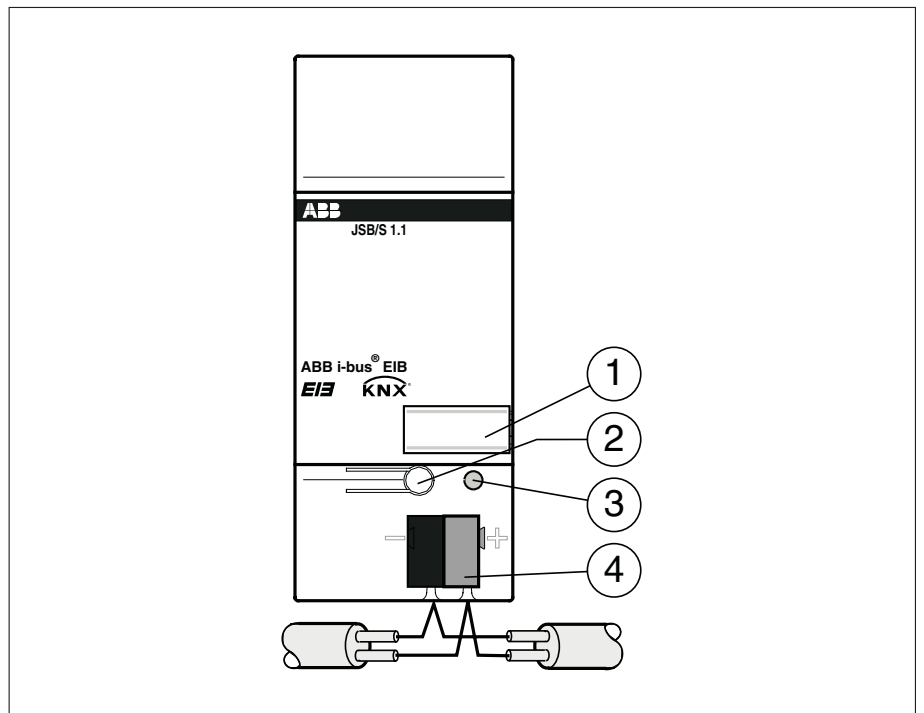

1 Label
2 Programming button

3 Programming LED
4 Bus connecting terminal

Dimension drawing

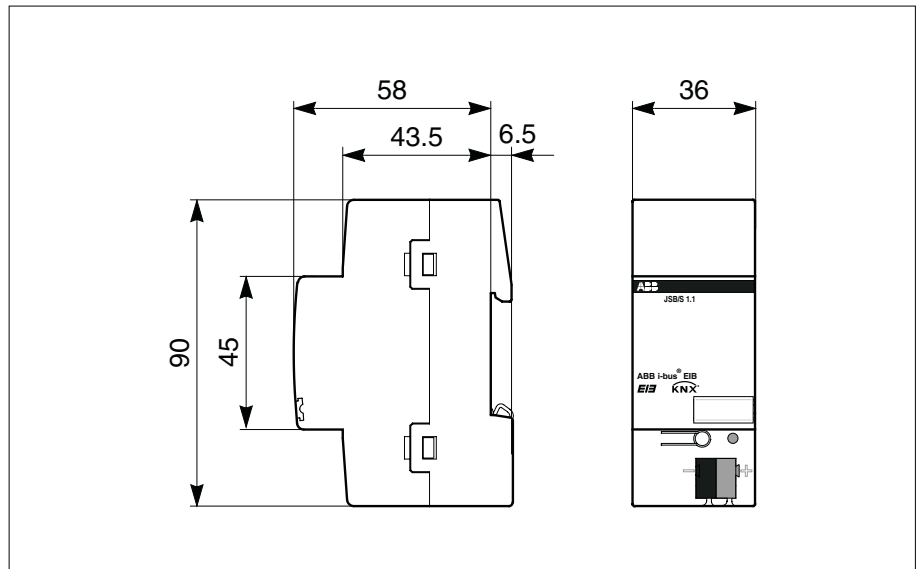

Note

The programming is carried out with ETS from version ETS2 V1.2a onwards.

The shutter control module is supplied with a downloaded application program. During commissioning, only the group addresses and parameters therefore need to be loaded. The full application program can however also be loaded if required. To do so, the device must first be unloaded.

After programming, the date and time must be set in the shutter control module. This can be carried out directly with ETS during the commissioning by sending corresponding telegrams to the input objects "Input date" and "Input time". Only then can the correct values of the output communication objects be calculated.



The functions of the shutter control module JSB/S 1.1 are especially suited to interaction with ABB shutter actuators for insertion in the distribution board and the shutter actuator modules for the ABB room controller!

3 Application and planning

3.1 Tracking the sun's position

3.1.1 Shutter control system that tracks the sun's position

General

With a shutter control system that tracks the sun's position, the shutters are positioned according to the current position of the sun i.e. the shutter is raised, lowered or moved to an intermediate position and the louvres are aligned.

It is therefore possible to implement

- optimum *anti-glare protection* with simultaneous maximum use of diffuse daylight and/or
- the optimum use of daylight through *daylight redirection* for the occupant of the room.

Anti-glare protection

In general, people prefer natural daylight to artificial lighting. The occupant of the room is however more likely to be disrupted by strong direct sunlight. Direct sunlight is unpleasant for the eyes and is blinding for example when you are using a screen. Diffuse daylight on the other hand illuminates the room without dazzling. It is therefore desirable to block direct sunlight while at the same time capturing as much diffuse daylight as possible in the room.

A shutter control system that tracks the position of the sun prevents direct sunlight and enables the maximum incidence of diffuse, ambient lighting, whereby the louvres are adjusted according to the position of the sun (see Fig. 1).

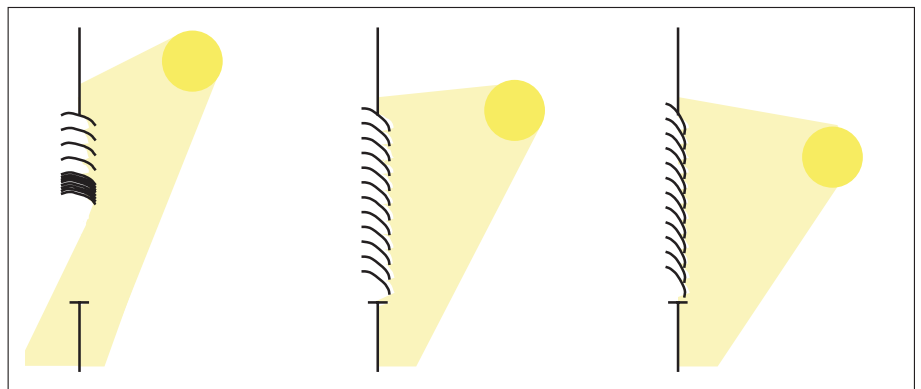

Fig. 1: Anti-glare protection

For anti-glare protection, matt materials are generally used for the louvres so that the incident rays of sunlight cannot be reflected inside the room or externally.

Daylight redirection

The incidence of direct sunlight is also avoided for the daylight redirection function. The direct rays of sunlight are directed into the room by reflective louvres so that the occupant of the room is not dazzled and there is as much daylight available as possible to illuminate the room (see Fig. 2).

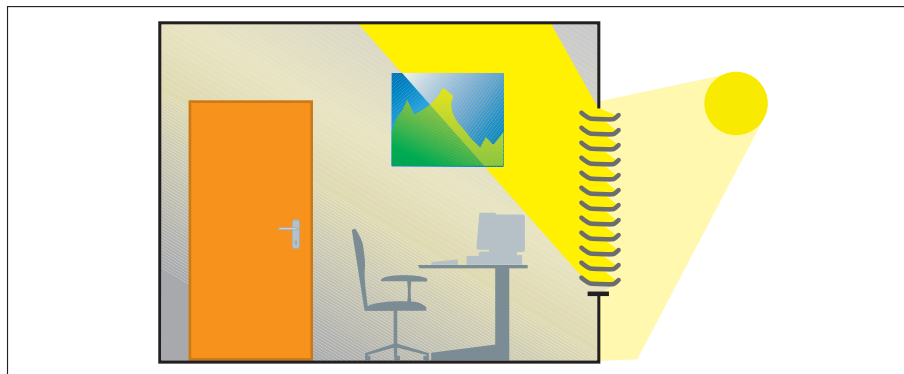

Fig. 2: Daylight redirection

For daylight redirection, slightly reflective materials are generally used for the louvres, so that the rays of sunlight are weakened (diffused) when they penetrate the inside of the room.

3.1.2 Setting up a shutter control system that tracks the position of the sun

To set up a shutter control system that tracks the position of the sun, two push buttons, a brightness sensor, a shutter control module and a shutter actuator are required (see Fig. 3).

With the help of the **push buttons**, the user of the room can raise and lower the shutter directly as well as activate/deactivate the automatic control system. If automatic control is activated, the shutter is automatically controlled by the shutter control module.

Via the **brightness sensor**, the shutter control module receives the information as to how strongly the sun is shining. In addition, the shutter control module calculates which direction the sun is shining in. Using this information, it determines which façades the sun is shining on and which façades should therefore be protected via anti-glare protection or daylight redirection. The shutter control module takes existing shadow objects into consideration (e.g. trees or the building opposite). The shadow progression is calculated as well as the exact period during which a window is shaded by one of these objects.

The **shutter control module** then sends the information to the shutter actuator whether the sun is shining on the respective window and in which position the shutter can offer optimum protection against the sun in this case.

This information is linked with other control commands in the **shutter actuator** (e.g. wind alarm or automatic heating/cooling) and the shutter is positioned according to the priority control system.

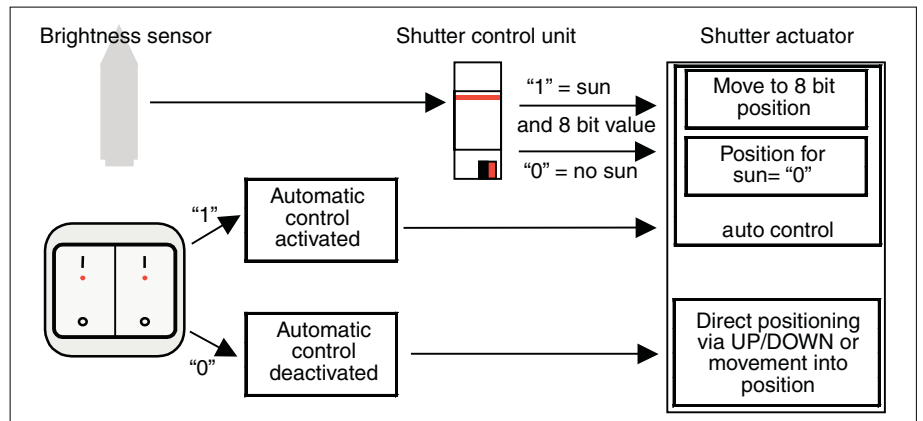

Fig. 3: Setting up a shutter control system that tracks the position of the sun

3.1.3 Planning notes

The following EIB components are required to set up a shutter control system that tracks the position of the sun (see also Fig. 4):

- shutter actuator
- push button sensor or universal interface + conventional push buttons
- brightness sensor
- shutter control module

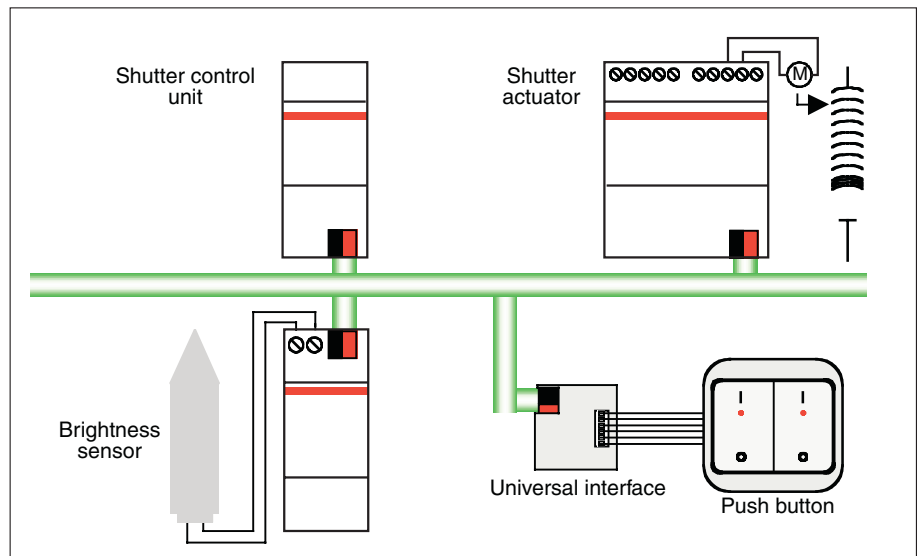

Fig. 4: Planning a shutter control system that tracks the position of the sun

The shutter control module can be operated as an independent clock, as a master clock or as a slave clock on the EIB. Several shutter control modules can therefore be synchronised with each other. If the shutter control module is operated as an independent clock or as a master clock, no further time switch is required. The internal clock in the shutter control module has an accuracy of max. +/- 2 seconds per day and a reserve power of at least 1 hour (typically: 12 to 24 hours).

The shutter control module can also be operated as a slave clock, if for example there is a master clock in the installation or if several shutter control modules should be synchronised in the same installation (e.g. several buildings). If an additional time switch is used, it must be a device that can send the time and date on the EIB.



The functions of the shutter control module JSB/S 1.1 are especially suited to interaction with ABB shutter actuators for insertion in the distribution board and the shutter actuator modules for the ABB room controller!

The shutter control module calculates the optimum sun protection position of the shutters according to a complex algorithm. The following serve as a basis for these calculations

- the position of the sun (see Chapter 3.2),
- the geometry of the louvres (see Chapter 3.3) and
- the casting of shadows (see Chapter 3.4).

3.2 Position of the sun

3.2.1 Position of the sun as a controlled variable

The position of the sun is the most important controlled variable for a shutter control system that tracks the position of the sun. The position of the sun works in two ways:

- relative to the façade: activation/deactivation of the louvre control and
- relative to the louvres: alignment of the louvres for anti-glare protection and daylight redirection.

Position of the sun relative to the façade

The louvre control is activated when rays of sunshine directly hit the windows of a façade. This is the case if the sun's intensity exceeds a certain brightness value and the sun is simultaneously positioned opposite the façade, so that the rays can fall directly (see Fig. 5).

If the sun is too weak or is not shining directly on the façade, the louvre control is deactivated and the shutter is moved to a parameterised position, generally right at the top to allow as much diffuse light as possible into the room.

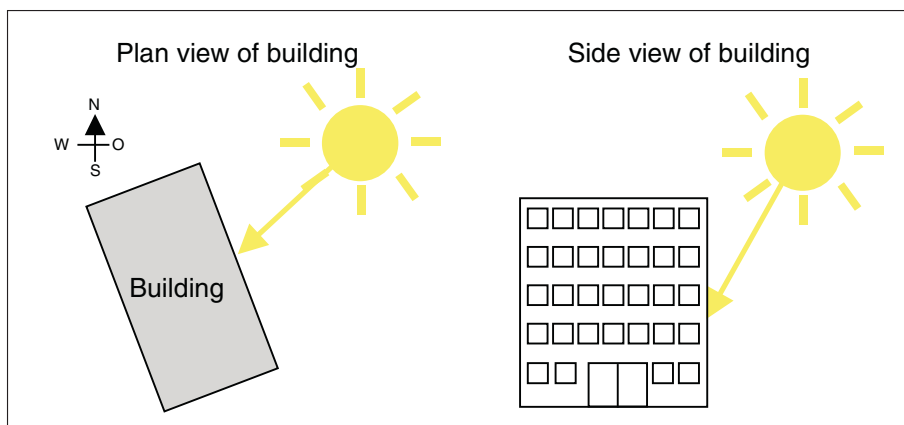

Fig. 5: Position of the sun

Position of the sun relative to the louvres

The angle of incidence of the rays of sunlight on the louvres determines the alignment of the louvres.

For anti-glare protection, the louvre is aligned so that direct sunlight cannot penetrate inside the room but the louvres are opened to the maximum in order to let as much diffuse light through as possible (see Fig. 6 on the left).

For daylight redirection, the louvre is aligned so that the sunlight cannot directly penetrate the room without reflection but is directed in the required direction (see Fig. 6 on the right).

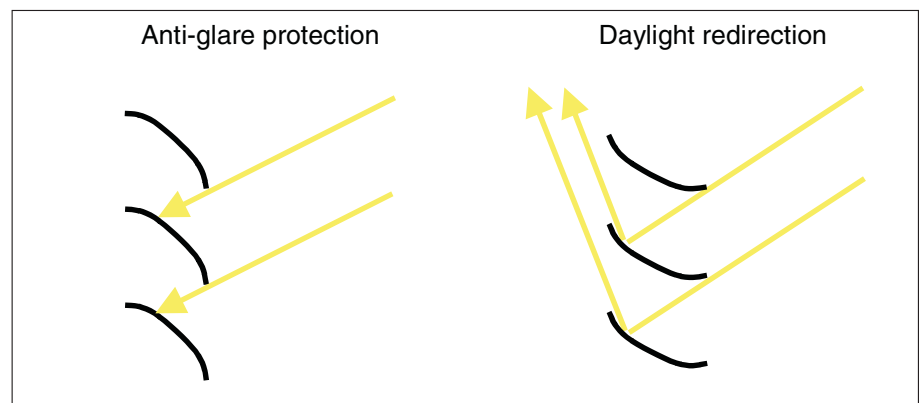

Fig. 6: Angle of incidence of the sun relative to the louvres

3.2.2 Calculating the position of the sun

The position of the sun is recalculated once per minute in the shutter control module. The following parameters serve as a basis for the calculation

- date and time
- building location
- façade orientation as well as the
- blind spot.

Date and time

The Universal Coordinated Time (UTC) applies as the basis for calculating the position i.e. the date and time at a degree of latitude of 0°. However, the local time is generally used in the EIB installation itself. The time zone as well as any special variations (e.g. daylight saving) must therefore be parameterised in the shutter control module.

Building location

The building location must be set with the parameters *Degree of latitude* and *Degree of longitude*.

**Practical tip!**

The exact location of your building can be read from a map or determined with a GPS or via the corresponding pages on the Internet (e.g. www.astro.com/atlas). Likewise, the position of the sun can be calculated on corresponding Internet pages (e.g. www.geocities.com/senol_gulgonul/sun)

Façade orientation

The façade orientation is the angle between the north-south axis and a line that runs vertically to the façade. When measuring the angle from the north end of the north-south axis, it must always be measured in an easterly direction (see Fig. 7).

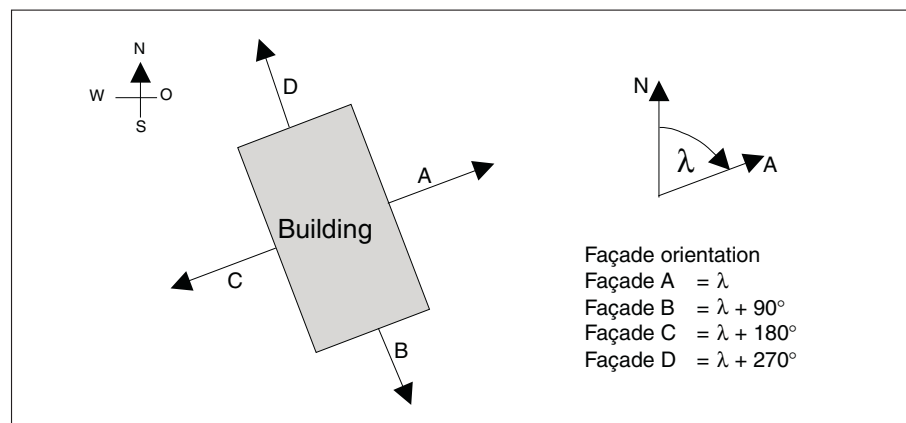

Fig. 7: Façade orientation

In this sense, a façade is the flat external wall of a building. If the external wall is curved or buckled, it must be divided into several façade sections which can be assumed to be flat. Even if different types of louvres are used within an external wall (e.g. vertical and horizontal louvres), they must be divided into several uniform façade sections.



Practical tip!

You can simply determine the façade orientation from a building's ground plan with a set square or directly with a compass on site.

Blind spot

The louvre control is activated when the sun is shining on the façade.

Via the blind spot, the activation of the louvre control can be limited to a specific angle of incidence for the sun's rays. If the sun is positioned within the parameterised blind spot, it is considered not to shine on the façade at all. Use this setting for the influence of e.g. balustrades.

Via the vertical blind spot, it is defined which surface angle of the sun relative to the façade activates the louvre control (see Fig. 8 on the left).

The horizontal blind spot determines the height and angle of the sun relative to the façade for activating the louvre control (see Fig. 8 on the right).

While the sun is located in the blind spot relative to the façade, the louvre control is not activated.

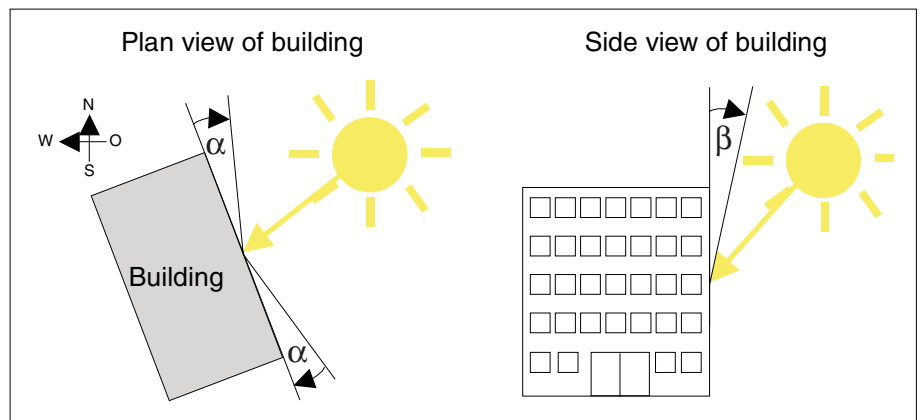

Fig. 8: Vertical blind spot α (left) and horizontal blind spot β (right)

3.2.3 Measuring the brightness

Not only the position of the sun but also the brightness of the sunlight determines whether the shutter is moved according to the calculated louvre position (*Position when sun = 1*) or the parameterised *Position when sun = 0*.

Number of brightness sensors

The majority of brightness sensors only record the sunlight at a certain angle of incidence. In order to detect the sunlight right round the building, several brightness sensors should be used simultaneously. The shutter control module can receive telegrams from up to 4 brightness sensors (e.g. north, south, east, west), whereby 3 brightness sensors are customary (in the northern hemisphere, the sun does not remain in the north while in the southern hemisphere, it does not remain in the south).

The received values are assigned an OR function i.e. if a brightness sensor reports that the threshold has been succeeded, the controller in the shutter control module is activated.

If a brightness sensor is used that is not dependent on direction, the shutter control module only receives a single brightness value which however takes all points of the compass into consideration.

Brightness levels

Two brightness levels can be processed in the shutter control module. When there is a normal level of sunlight, it is possible for example to set less oversteer and/or a higher position for the shutter than when the sunlight is glaring.

Four brightness values can be processed separately for each brightness level. The following applies to the received brightness values:

1. If all the brightness sensors receive a brightness value that falls below the threshold value, the shutter control is deactivated and the shutter moves into the parameterised *Position when sun = 0*.
2. If at least one of the brightness sensors of level 1 receives a brightness value that exceeds the threshold value while the brightness sensors of level 2 receive a brightness value that falls below the threshold value, the shutter control is carried out in accordance with brightness level 1.

3. If at least one of the brightness sensors of level 2 receives a brightness value that exceeds the threshold value, the shutter control is carried out in accordance with brightness level 2 (regardless of the value of the brightness sensors of level 1).

An override of the optimum louvre angle can be parameterised separately for each brightness level as well as a different shutter height.

Types of brightness sensors

Brightness sensors (also light sensors) or light value switches with a detection range of 0 to 20,000 lux or better still 0 to 100,000 lux are suitable. Twilight sensors are not suitable for this function due to their low detection range which is often below 1,000 lux. Even better suitable for the application is a pyranometer.

All brightness levels have to be adapted individually to the user's preference. If no such directives are made, it is recommended to use 20.000 Lux for brightness level 1 and 35.000 Lux for brightness level 2.

3.2.4 Delay periods and intermediate position

To prevent the shutter being continually raised and lowered due to variable amounts of cloud, delay periods can be set in various EIB components e.g. in the brightness sensor or the weather station, which only sends a value via the EIB if it has been constant for a set period or in the shutter actuator which only evaluates the received value if no other values have been received via the EIB for a set period.

A delay period can also be combined with an intermediate position in the shutter control module. If the sun is obscured temporarily, at first only the position of the louvres is adapted to a set position. The value when sun = 0 is sent via the EIB once the delay period has elapsed.

The connection between the individual delay periods as well as the reaction of the shutter is represented in Fig. 9.

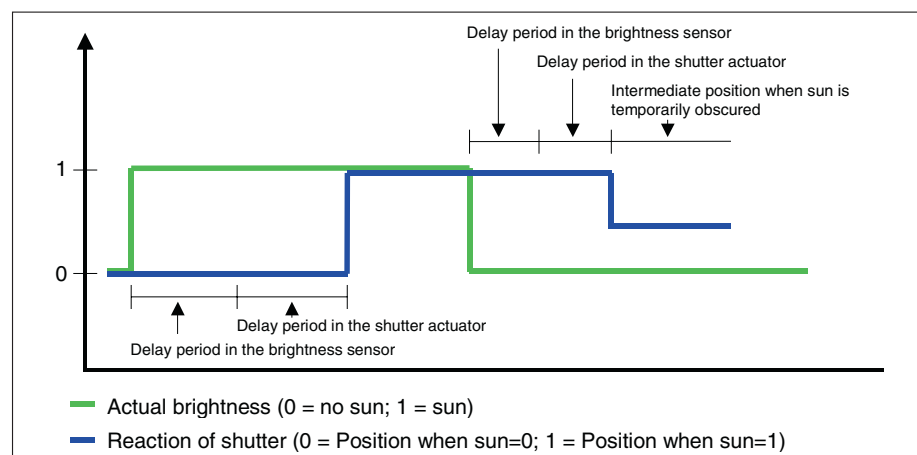

Fig. 9: Delay periods and intermediate position

If automatic control is activated for example approx. 30 seconds or 1 minute after a brightness value has been exceeded, this has either been set in the brightness sensor or in the shutter actuator (parameter: *Delay when sun = 1*).

Approx. 2 minutes after the brightness value has fallen below the threshold (e.g. sun is obscured by a cloud), the shutter should first be moved to an intermediate position (shutter remains at the same height, louvres are opened). The shutter should only be raised if the occupant of the room has not been dazzled by the sun for a further 5 minutes. A delay period of 2 minutes must therefore be set in the brightness sensor and the duration of the intermediate position should be parameterised in the shutter control module (parameter: *Period during which the sun is temporarily obscured*). The parameter *Delay when sun = 0* must be set to "0" in the shutter actuator.

3.3 Geometry of the louvres

3.3.1 Horizontal louvres/ vertical louvres

General

The geometry of the louvres exerts a significant influence on louvre control for anti-glare protection and daylight redirection. The louvres can only be controlled accurately if the most important parameters have been set.

Different louvres are used depending on the application. Horizontal louvres are for example mainly used on the outside of windows while textile vertical louvres are used on the inside.

The profile of the louvre also differs depending on the type of louvre. The most frequent louvre profiles are flat and slightly concave louvres but serrated profiles are also common e.g. in the case of horizontal louvres with light redirection.

Louvre width and spacing

The parameters *Louvre width* and *Louvre spacing* represent the most important geometrical data for the anti-glare protection function. The optimum louvre angle is calculated from these two parameters depending on the position of the sun (see Fig. 10).

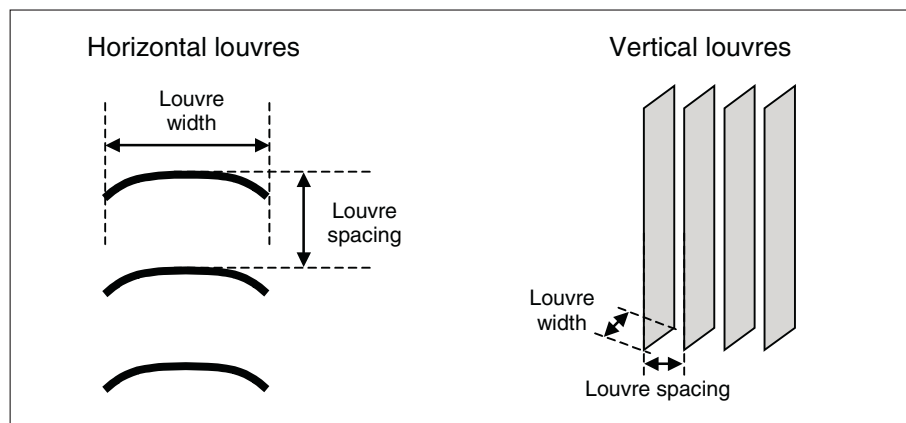

Fig. 10: Louvre width and spacing



Practical tip

Information about the louvre width and spacing is generally supplied by the manufacturer of the shutter in the data sheet. If this data is not available, both dimensions can be measured with a ruler.

Angle at maximum opening (louvre position 0 %) and maximum closing (louvre position 100 %)

The angle of the louvre when it is fully opened and when it is fully closed must be set as parameters.

The angle at maximum opening is identical to the angle between the vertical and the position which the louvre adopts after an UP command (value "0").
The angle at maximum closing is identical to the angle between the vertical and the position which the louvre adopts after a DOWN command (value "1").

The angle is measured between an imaginary line which links the sides of the louvres and

- the vertical for horizontal louvres or
- the horizontal for vertical louvres (see Fig. 11).

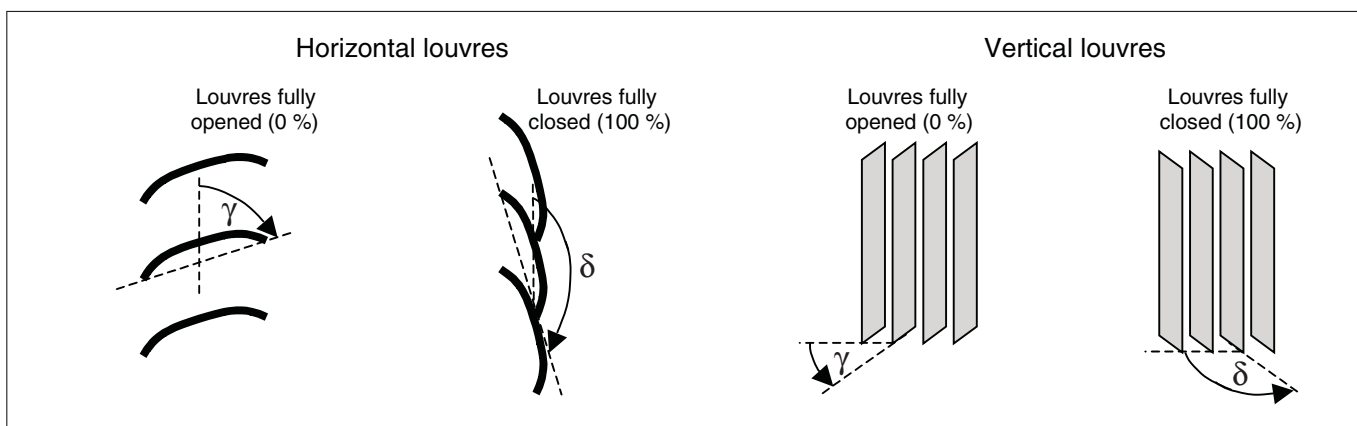

Fig. 11: Angle at maximum opening γ or maximum closing δ

**Practical tip!**

The angle at maximum opening and closing is information that is generally provided by the manufacturer of the shutter in the data sheet. If this data is not available, these two dimensions can be measured with a ruler and a set square e.g. according to Fig. 12.

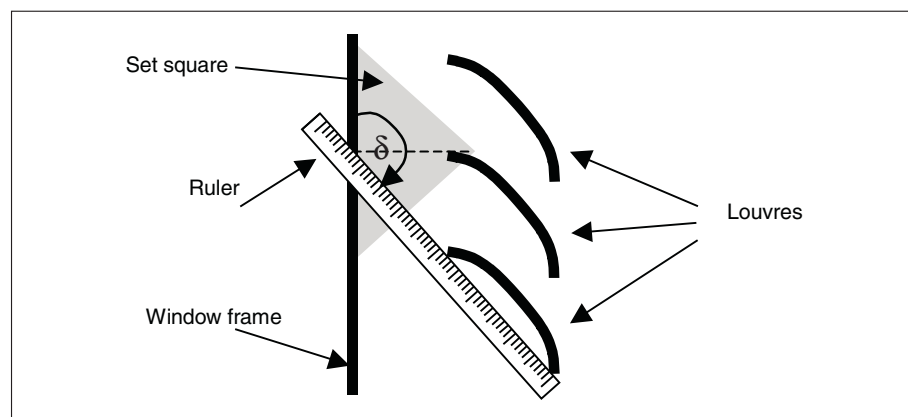

Fig. 12: Measuring the angle at maximum closing (louvre position 100 %)

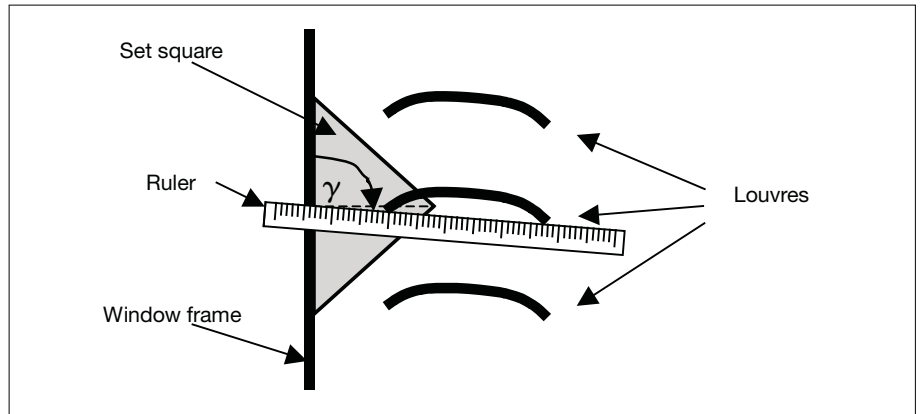

Fig. 13: Measuring the angle at maximum opening (louvre position 0 %)

3.3.2 Horizontal louvres with light redirection

General

The daylight redirection function requires the louvres to have additional characteristics. They should essentially be reflective so that the daylight can be directed into the room.

Horizontal louvres are used for daylight redirection and they generally direct the rays onto the ceiling. Daylight redirection using vertical louvres is not customary.

Variation of the reflective surface

Serrated profiles that are also reflective are mainly used for daylight redirection. It is therefore possible to implement both an anti-glare protection function and the daylight redirection function with a directional louvre.

A reflective surface is incorporated in the directional louvre which is used to reflect the daylight into the room. The reflective surface can deviate from a direct connection with the sides of the louvres. This angular variation must be entered as a parameter (see Fig. 14).

If the angular variation is in a clockwise direction as shown in Fig. 14, a positive value must be entered (“+”). When there is an anticlockwise variation, a negative value must be entered (“-”).

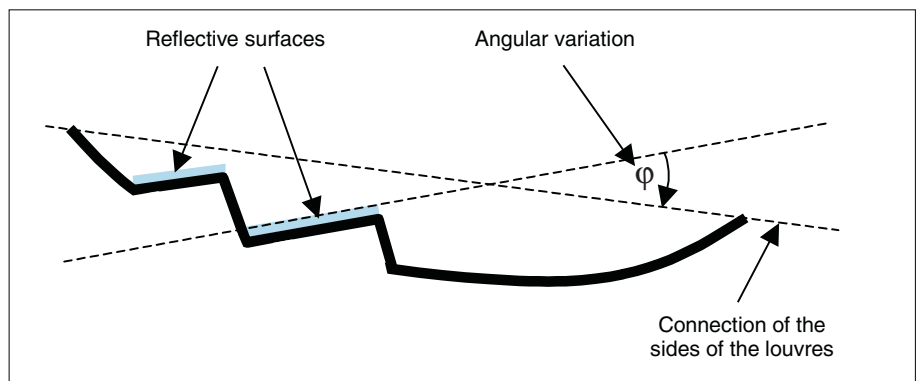

Fig. 14: Angular deviation φ of the reflective surface for directional louvres

**Practical tip!**

The angular variation of the reflective surface is generally provided by the manufacturer of the shutter in the data sheet. If this data is not available, these two dimensions can be measured with a ruler and a set square e.g. according to Fig. 15.

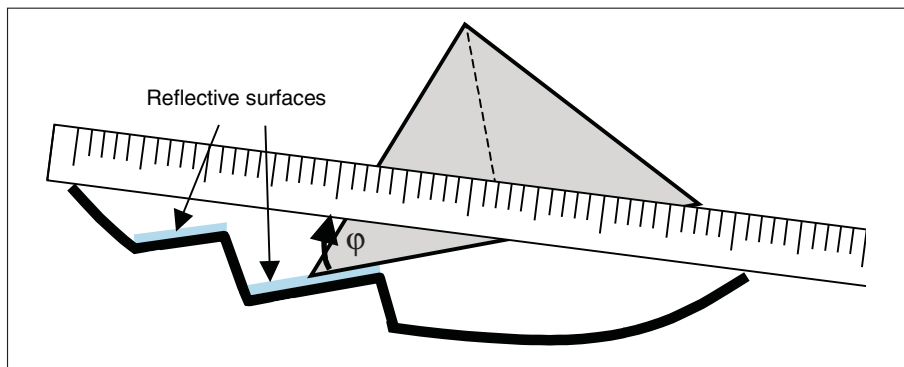

Fig. 15: Measuring the angular variation ϕ

Light emission angle in the room

Depending on the room's usage, the directed daylight can be reflected into the room with a different light emission angle. If there is a desk directly in front of the window for example, a very small light emission angle should be selected so that the sun's rays are reflected onto the ceiling of the room and do not disrupt work on the screen (see Fig. 16).

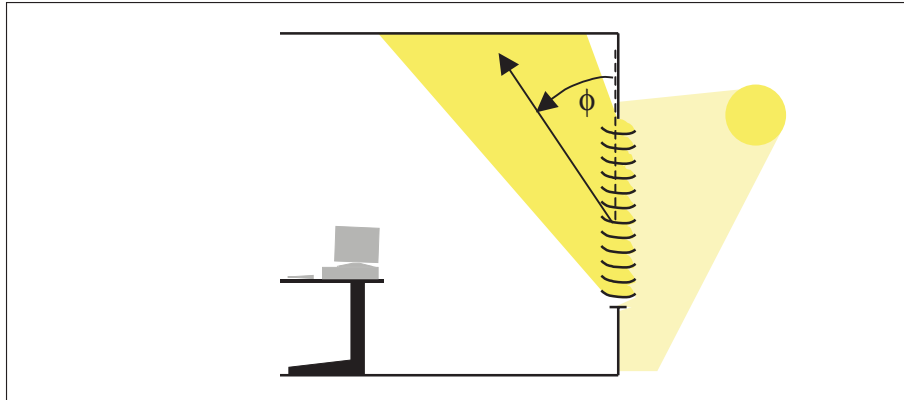

Fig. 16: Light emission angle ϕ



The optimum light emission angle is only rarely maintained as the louvres primarily carry out the anti-glare protection function. The louvre is only positioned according to the required light emission angle with the limited degree of freedom permitted by anti-glare protection. There is also a scattering of the reflected light on the reflective surface.

There are therefore frequent deviations from the required light emission angle with daylight redirection.

3.4 Casting shadows**3.4.1 Casting shadows**

Rays of sunlight do not always hit the façade unhindered. There are often objects opposite the façade e.g. other buildings or trees which generate various types of shadows depending on the position of the sun (see Fig. 17).

It can therefore occur that a shutter is controlled according to the position of the sun, although the associated window is shaded by an object which casts a shadow. Shadow objects can therefore be set in the shutter control module so that shutter control with tracking of the sun's position is deactivated for shaded windows and the shutter moves into a parameterised position. The shutter is then for example raised fully in order to let as much diffuse light as possible into the room.

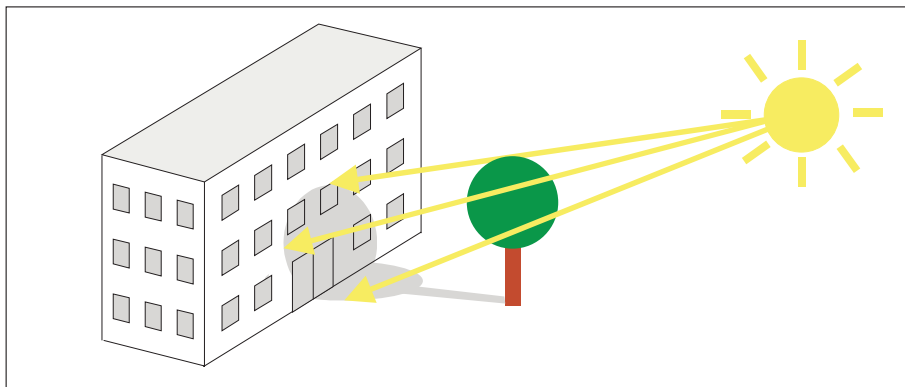

Fig. 17: A tree as a shadow object

3.4.2 Windows/window groups

Different windows can be affected by the casting of shadows depending on the position of the sun. A window for example that is in the blazing sun at 10.00 can already be shaded by a tree at 11.30 or vice versa, while the rays of sunlight are now falling on another window.

The façade must therefore now be divided so that each window can be controlled individually. Alternatively, several windows can be combined in groups, which are affected to the same extent by the casting of the shadow.

The parameterisation of individual windows or window groups is made easier by the option of grid programming. This can be applied if all the windows are arranged in a constant grid system i.e. if all the windows are placed at the same horizontal and vertical intervals. The necessary parameters for grid programming are indicated in Fig. 18.

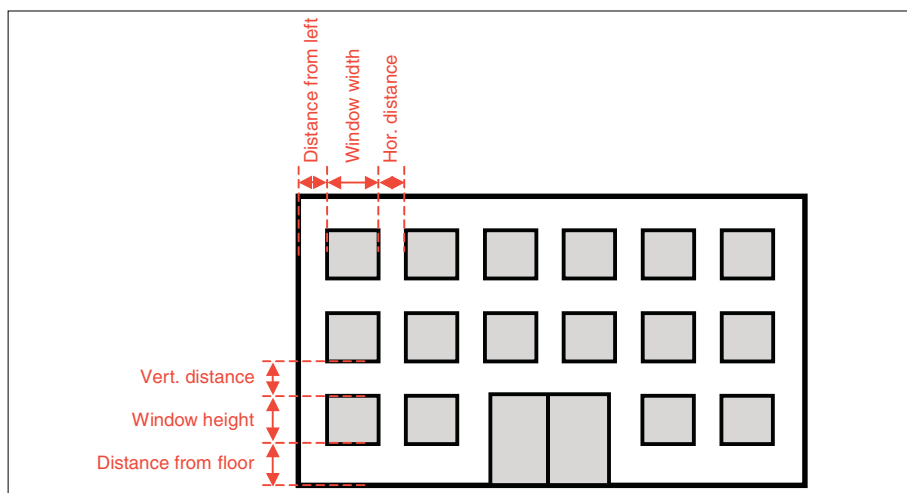

Fig. 18: Parameterisation of a window grid

If grid programming cannot be applied due to the geometry of the façade, each window must be parameterised individually or several windows are combined as a window group. A window group consists of several windows which are affected to the same extent by a shadow object. The more accurate the control should be, the fewer windows should be combined into a group. In the best scenario each window should be controlled individually (see Fig. 19).

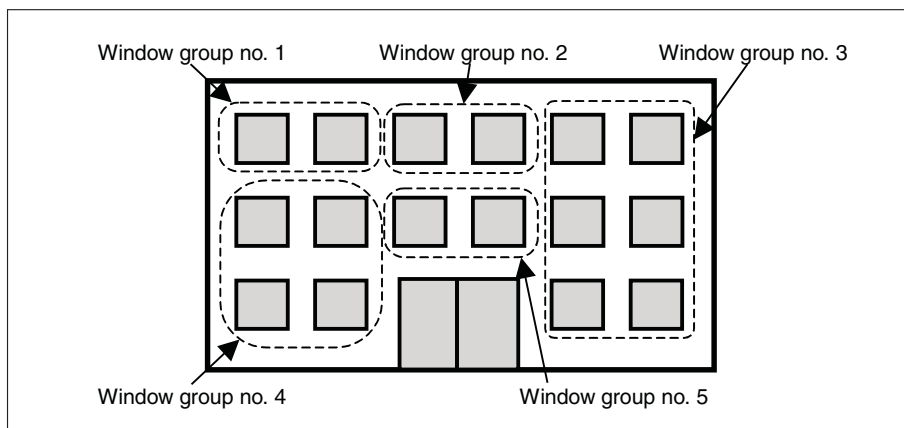

Fig. 19: Example of window groups

To configure window groups, the height and the distance must be entered as well as the width of the window group.

The position of the window group is measured as a height and distance, starting with the bottom left corner of the façade (see Fig. 20). The height is measured from the bottom to the top corner of the window group. The distance is measured from the left end of the façade to the left corner of the window group. The width is the dimension between the left and right corner of the window group.

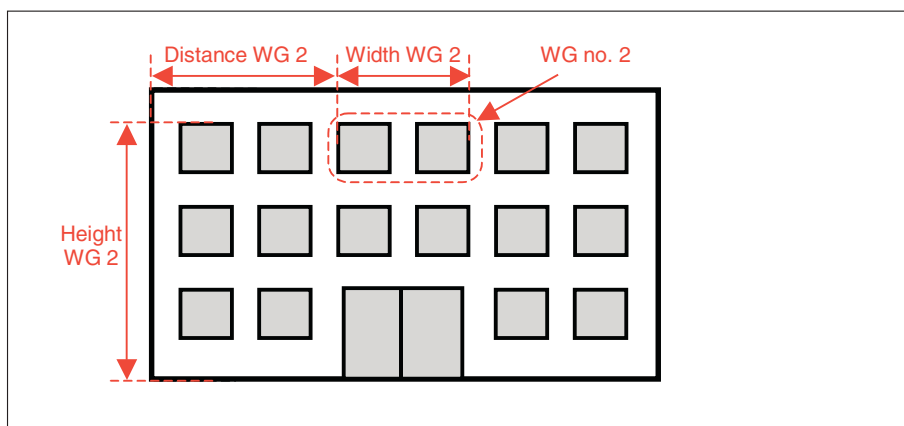

Fig. 20: Parameterisation of window groups



Practical tip!

The dimensions of a façade can be taken from the plan of the façade. Alternatively, the 6 dimensions required can be measured with a tape measure when the façade is programmed using the grid system.

3.4.3 Shadow objects

Shadow objects are striking objects in the surrounding landscape next to the façade, as for example high buildings or large trees or groups of trees. It is not necessary to consider smaller contours like small trees, if the shadowing influence is only of a short period. It is likewise not necessary to consider chains of hills or the smooth silhouette of smaller buildings. In this case, the shadowing influence is measured by the brightness sensor.

To calculate the influence of a shadow object on the various window groups, the location of the object relative to the façade as well as its height must be entered as parameters. The object can be parameterised as a rectangle or a circle.

Rectangle

A rectangular shadow object is parameterised via the position of its side that lies opposite the façade, its height and its depth. The X/Y co-ordinates of opposing side of the object and its depth are determined as shown in Fig. 21. The X/Y co-ordinates are measured starting from the left corner of the façade.

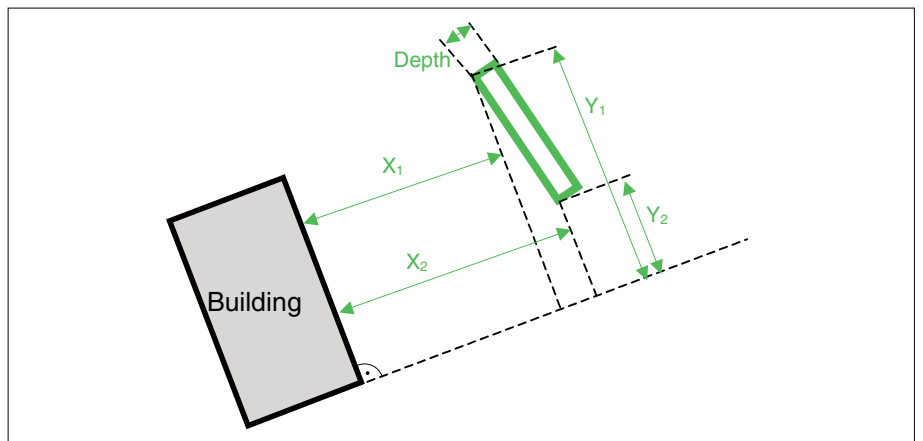

Fig. 21: Location of shadow object no. 1 relative to the façade

If one of the vertexes is located underneath the building, the position must be entered as a negative value (see Fig. 22).

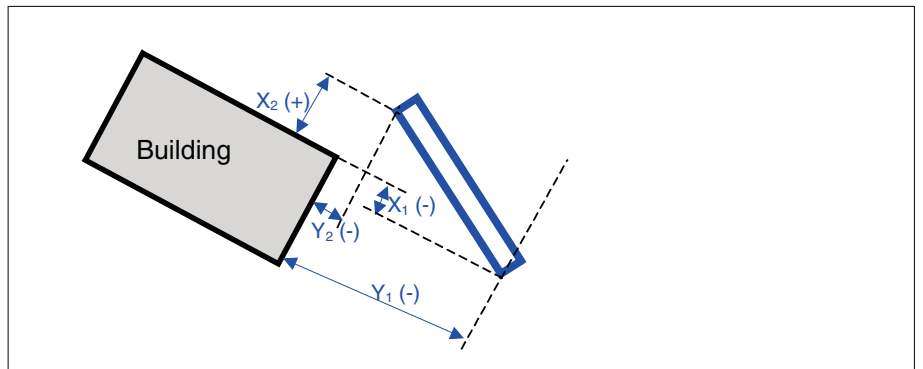

Fig. 22: Location of shadow object no. 2 relative to the façade

Circle

A circular shadow object is parameterised via the position of its central point, its diameter and its height. The X/Y co-ordinates of the central point and the diameter are determined as shown in Fig. 23. The X/Y co-ordinates are measured starting from the left corner of the façade.

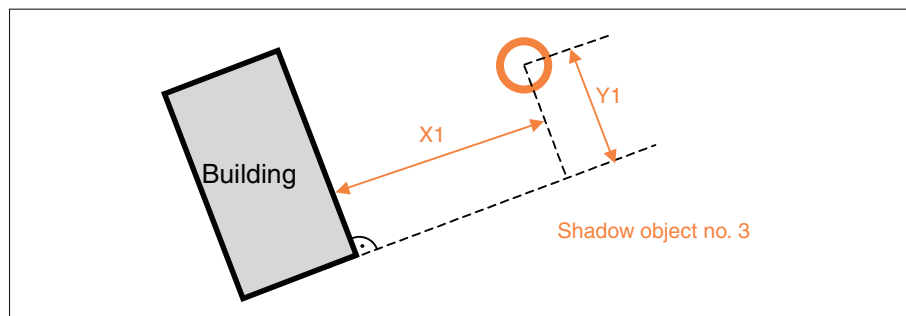

Fig. 23: Location of shadow object no. 3 relative to the façade



Practical tip!

The location of a shadow object can be taken from a ground plan of the area. Alternatively, the location of the object can be paced out.

Height of the shadow object

The height of the object casting shadows is measured relative to the bottom corner of the façade. The height is the dimension between the base point of the building and the upper point of the object (see Fig. 24).

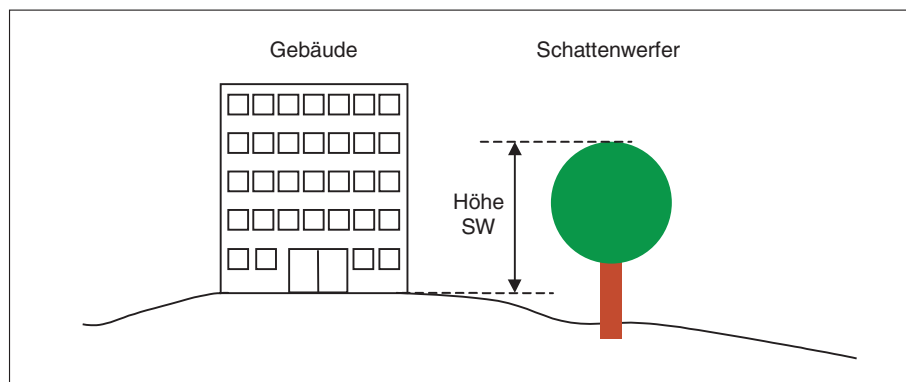

Fig. 24: Height of shadow object

Seasonal influence of the shadow object

Via the parameters *Shadow is cast from* and *Shadow is cast until*, seasonal changes in the shape of the object can be taken into account. In particular, it is possible to enter the periods when trees come into leaf. Depending on the type of tree, their foliage can for example cast a shadow in the summer but when they lose their leaves in the autumn they no longer act as a shadow object.

**3.4.4 Planning examples:
Division of façades**

The shutter control module controls 4 façades, each with up to 50 windows/window groups. In an ideal situation, this is adequate for controlling a small building completely. In practice however, several shutter control modules are frequently required in an EIB installation due to architectural diversity. It can arise that individual shadow objects have a different effect on the various façades or specific rooms should not be controlled by the grid system but be defined by the user e.g. meeting rooms.

The following planning examples explain using selected sample projects how the façades are divided into individual projects and how the required number of shutter control modules is calculated.

Example 1: Façade with more than 50 windows

The division of the façades should be planned for a large building (see Fig. 25). The building has 15 floors (ground floor, 1st floor to 14th floor) and there are 45 windows on each floor. The windows are distributed across the façade in a grid. The bordered windows are meeting rooms and should be controlled as a window group. All the relevant shadow objects are not higher than the 8th floor.

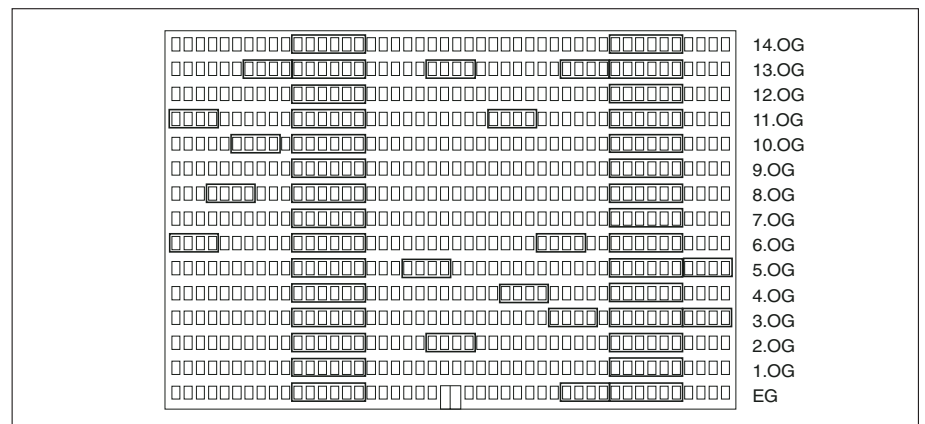

Fig. 25: Façade with more than 50 windows

As the relevant shadow objects are not higher than the 8th floor, all the windows above this floor can be controlled identically. These floors do not need window groups or a grid system. The façade orientation is the same as for all the other windows. One of the central communication objects for façades A to D can therefore be used e.g. “Façade A – Sun”.

The shutter control module can control up to 4 façades, each with a maximum of 50 windows/window groups. As each window should be controlled individually, an entire façade must be used in the shutter control module for one floor. A shutter control module can therefore control a maximum of 4 floors. The floors are therefore divided as follows:

- Ground floor = Façade A (shutter control module no. 1)
- 1st floor = Façade B (shutter control module no. 1)
- 2nd floor = Façade C (shutter control module no. 1)
- 3rd floor = Façade D (shutter control module no. 1)
- 4th floor = Façade A (shutter control module no. 2)
- 5th floor = Façade B (shutter control module no. 2)
- 6th floor = Façade C (shutter control module no. 2)
- 7th floor = Façade D (shutter control module no. 2)
- 8th floor = Façade A (shutter control module no. 3)

The option “1 floor with 50 windows” is set as the grid for each façade. A unique communication object must be linked for each window e.g. “Façade A: 1st floor, window 1 – Sun”. The communication objects for the windows of the meeting rooms remain without connection.

2 complete shutter control modules as well as a façade of the third shutter control module are therefore required for the grid programming of the 8 lower floors. The windows of the meeting rooms must be programmed by the user. Up to 50 windows/window groups can be programmed in this way in the shutter control module. 46 meeting rooms are specified in the plan. Façade B of the third shutter control module is therefore used for the meeting rooms. A unique communication object must be linked for each window group e.g. “Façade A: Window 1 – Sun”.

In this case, 3 shutter control modules are required to control the façade. A reserve is also retained at the same time which can for example be used for future window groups.

Variant:

In large façades, it is often the case that the façade is structured by a primary grid system in addition to the window grid. In this case, always 3 windows or always 4 windows are grouped together for example and the room division must always be oriented to this primary grid e.g.:

- Primary grid: 3 windows
→ Possible room sizes: 3 windows, 6 windows, 9 windows etc.
- Primary grid: 4 windows
→ Possible room sizes: 2 windows, 4 windows, 8 windows etc.

In this case, the grid programming in the control module can alternatively be oriented to the primary grid system. In the case of a 4-window primary grid, 4 windows can always be grouped together. During programming, it should be ensured when entering the width that it is not the width of one window that is required but the total width of the 4 windows including the spacing inbetween.

Example 2: Round building

The division of the façades should be planned for a round building (see Fig. 26). The building has 4 floors (ground floor, 1st floor to 3rd floor) and there are 20 windows on each floor. The windows are distributed over the façade in a grid system.

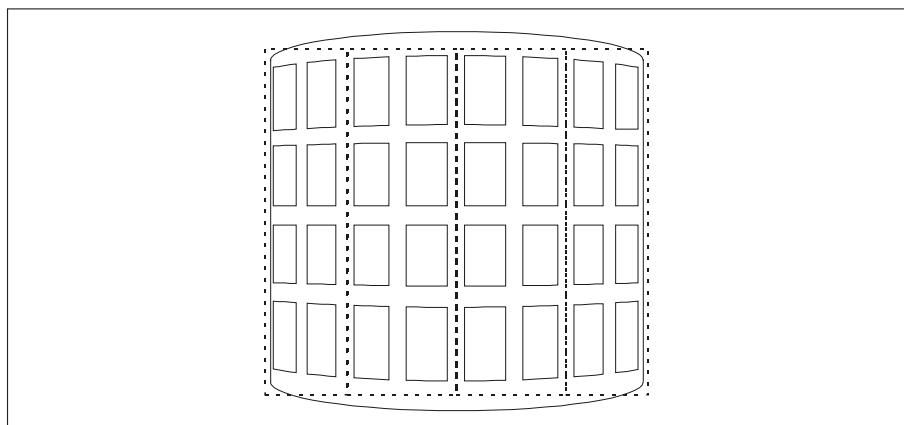

Fig. 26: Round building

In contrast to façades in a straight line, all the windows on a floor in a round building face a different direction and are therefore lit by the sun at different times. In this example, two windows per floor as well as all the windows above them should be combined into a façade (hatched frame).

The option “25 floors with 2 windows each” should be set as the grid system for each façade. The façade orientation is determined based on the central point of both windows. The setting “0” is recommended for the parameter “Vertical blind spot” so that the sunlight can be detected as early as possible. A unique communication object must be linked for each window e.g. “Façade A: 1st floor, window 1 – Sun”.

In this division, there are 20 windows per floor, 2 windows per façade and a total of 10 façades, therefore 3 shutter control modules are required. The remaining two façades in the third shutter control module can be reserved for special rooms.

Example 3: Angled building complex

The façade division should be planned for a building complex with two angled building sections (see Fig. 27). Both building sections have three floors (ground floor, first floor, second floor) and are linked by a passageway. All the façades of the individual building sections are shaded using a shutter control system that tracks the position of the sun. The windows are distributed over the façade in a grid system. At the same time, the building sections themselves cast shadows on each other. The passageway is not shaded but must also be taken into account as a shadow object.

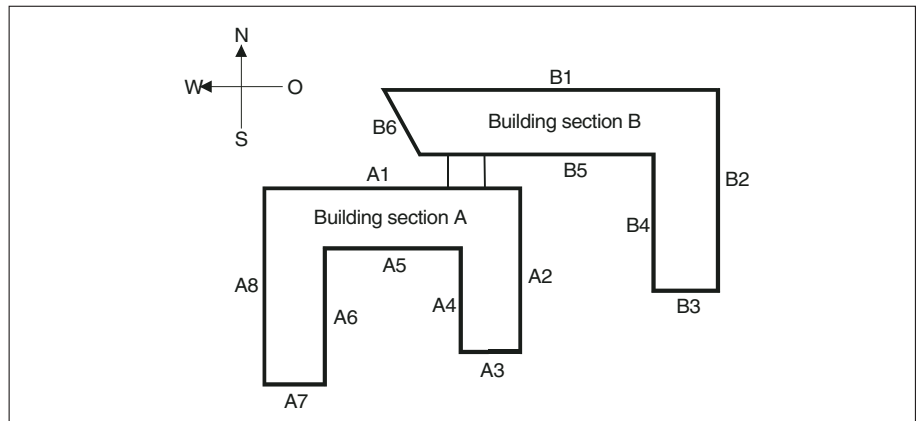

Fig. 27: Angled building complex

Each façade is considered separately. Building section A consists of 8 façades (A1 to A8). Building section B consists of 6 façades (B1 to B6). Under the condition that there are no other shadow objects positioned around the building complex, the façades can be divided up in the following way:

North-facing:

A1: Façade A1 consists of 3 floors, each with 34 windows. The shutter control module can control a maximum of 50 windows/window groups per façade (e.g. one floor with 50 windows or 5 floors with 10 windows each).

In this example, each window should be controlled individually. 3 façades of the shutter control module are therefore already occupied: Grid dimensions: "1 floor with 50 windows", ground floor = façade A, 1st floor = façade B, 2nd floor = façade C.

A unique communication object must be linked for each window e.g. "Façade A: 1st floor, window 1 – Sun" (module 1, façade A to C).

B1: No shadow objects need to be considered for façade B. The façade orientation is the same as for A1. One of the central communication objects of façades A to C can therefore be used e.g. "Façade A – Sun".

Remainder: Almost a complete shutter control module is therefore needed for the two north-facing façades. The last free façade D in the module should be reserved for special user-defined divisions e.g. for meeting rooms.

East-facing:

A2: Façade A2 consists of 3 floors with 21 windows each. One façade of the shutter control module is also not sufficient in this case. Two façades are required (grid dimensions: "2 floors with 25 windows each", Ground floor = Façade A, floor 1; 1st floor = Façade A, floor 2; 2nd floor = Façade B, floor 1).

A6: Façade A6 consists of 3 floors with 18 windows each. One façade of the shutter control module is also not sufficient in this case. Two façades are required (grid dimensions: "2 floors with 25 windows each", Ground floor = Façade C, floor 1; 1st floor = Façade C, floor 2; 2nd floor = Façade D, floor 1).

B2: No shadow objects need to be considered for façade B2. The façade orientation is the same as for A2 and A6. One of the central communication objects of façades A to C can therefore be used e.g. "Façade A – Sun".

Remainder: The second shutter control module is thus fully occupied. A new shutter control module or the remainder of one of the subsequent shutter control modules must be used for any special user-defined divisions e.g. meeting rooms.

South-facing:

A5: The façade A5 consists of 3 floors with 18 windows each. Two façades of the shutter control module are required (grid dimensions: “2 floors with 25 windows each”, Ground floor = Façade A, floor 1; 1st floor = Façade A, floor 2; 2nd floor = Façade B, floor 1).

B5: Façade B5 consists of 3 floors with 31 windows each. Three façades of the shutter control module are required. The function can thus no longer be integrated in the third module and a fourth module must be programmed (grid dimensions: “1 floor with 50 windows”, Ground floor = Façade A; 1st floor = Façade B; 2nd floor = Façade C).

A3, A7, B3: No shadow objects need to be considered for façades A3, A7 and B3. The façade orientation is the same as for A5 and B5. One of the central communication objects of façades A to B of the third shutter control module or of façades A to C of the fourth shutter control module can therefore be used e.g. “Façade A – Sun”.

Remainder: There are still two façades available in the third module and one façade in the fourth module. They can be used for the west-facing façades. It is however advisable to keep these spare façades free for special user-defined divisions for the south-facing façades or for other façades (e.g. east-facing).

West-facing:

A4: Façade A4 consists of 3 floors with 13 windows each. Two façades of the shutter control module are required (grid dimensions: “2 floors with 25 windows each”, Ground floor = Façade A, floor 1; 1st floor = Façade A, floor 2; 2nd floor = Façade B, floor 1).

B4: Façade B4 consists of 3 floors with 18 windows each. Two façades of the shutter control module are required (grid dimensions: “2 floors with 25 windows each”, Ground floor = Façade C, floor 1; 1st floor = Façade C, floor 2; 2nd floor = Façade D, floor 1).

A8: No shadow objects need be considered for façade A8. The façade orientation is the same as for A4 and B4. One of the central communication objects of façades A to D can therefore be used e.g. “Façade A – Sun”.

Remainder: The fifth shutter control module is thus fully occupied. A new shutter control module or the remainder of the third or fourth shutter control modules must be used for any special user-defined divisions e.g. meeting rooms.

Other:

B6: Façade A6 consists of 3 floors with 7 windows each. One façade of the shutter control module is required (grid dimensions: “5 floors with 10 windows each”, Ground floor = Façade A, floor 1; 1st floor = Façade A, floor 2; 2nd floor = Façade A, floor 3). Either a sixth shutter control module is required or the remainder of the third or fourth shutter control module can be used.

At least 5 shutter control modules are therefore required in total for this project. The same project forms the basis of the planning example for shadow objects in Chapter 3.4.5.

3.4.5 Planning example: Shadow objects

The programming of shadow objects is represented in the following example. We need to go back to example 3 in the previous chapter (see Fig. 28).

The building complex is angled in such a way that individual building sections cast shadows on each other. The two building sections must therefore be divided into several shadow objects. As the slanted shape of façade B6 cannot be truly depicted in the shutter control module, the shape is simulated by a rectangle.

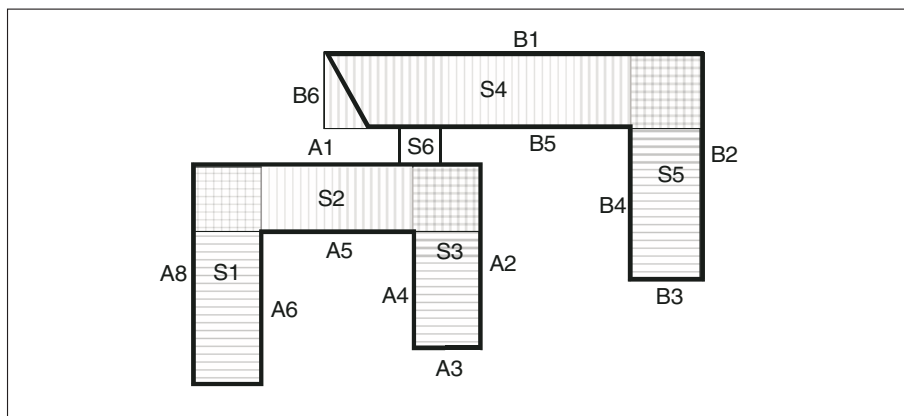

Fig. 28: Building sections as shadow objects

The following shadow objects influence the individual façades:

– Façade A1:	S4, S5, S6	Façade B1:	None
– Façade A2:	S4, S6	Façade B2:	None
– Façade A3:	None	Façade B3:	S3
– Façade A4:	S1, S2	Façade B4:	S3, S4, S6
– Façade A5:	S1, S3	Façade B5:	S2, S3, S5, S6
– Façade A6:	S2, S3	Façade B6:	S2
– Façade A7:	None		
– Façade A8:	None		

Façades A1 (3 shadow objects) and B1 (none) are controlled with the first shutter control module. Therefore only 3 of the possible 20 shadow objects per shutter control module are occupied. Other shadow objects can therefore be taken into account such as buildings or trees in the surrounding area.

Façades A2 (2 shadow objects), A6 (2 shadow objects) and B2 (none) are controlled with the second shutter control module. Therefore 4 of the 20 possible shadow objects are occupied.

Façades A5 (2 shadow objects) and B6 (1 shadow object) are controlled with the third shutter control module while façade B5 (4 shadow objects) is controlled with the fourth module. Therefore 3 or 4 of the possible 20 shadow objects are occupied. The remaining façades A3, A7 and B3 are not shaded by the building complex and therefore have 0 shadow objects. They can therefore be divided as required on the third or fourth shutter control module. The situation changes if other objects that cast shadows need to be considered. These three façades must then be divided up differently depending on the situation or in extreme cases they need their own shutter control module.

Façades A4 (2 shadow objects), A8 (none) and B4 (3 shadow objects) are controlled with the fifth shutter control module. Therefore 5 of the possible 20 shadow objects are occupied.

Coordinates for shadow objects for planning example

(1 mm in (Fig. 28) corresponds to ca. 1 m in reality)

All coordinates are measured from the left outer building edge of the façade in question. If a shadow object has an effect on more than one façade, it has to be parameterized once for each façade.

Façade A1

S4:	X1: 4	Y1: - 26	X2: 4	Y2: 19	Depth: 8
S5:	X1: 0	Y1: - 26	X2: 0	Y2: - 18	Depth: 8
S6:	X1: 0	Y1: 5	X2: 0	Y2: 5	Depth: 4

Corresponding to the shadow object S5, negative X values can be ignored in the case of parallel buildings.

Fassade A4

S1:	X1: 18	Y1: - 8	X2: 18	Y2: 18	Depth: 8
S2:	X1: 0	Y1: - 8	X2: 0	Y2: 0	Depth: 26

Corresponding to the shadow object S2, all coordinates have to be entered in that way, that the values for Y1 and Y2 are different, in any case.

4 Project design and programming



For a rapid parameterisation of the shutter control unit JSB/S 1.1, the necessary data should be determined in the preliminary stages. A planning checklist is therefore included in chapter 5 (appendix).

4.1 Parameters

4.1.1 Parameter window: "General"

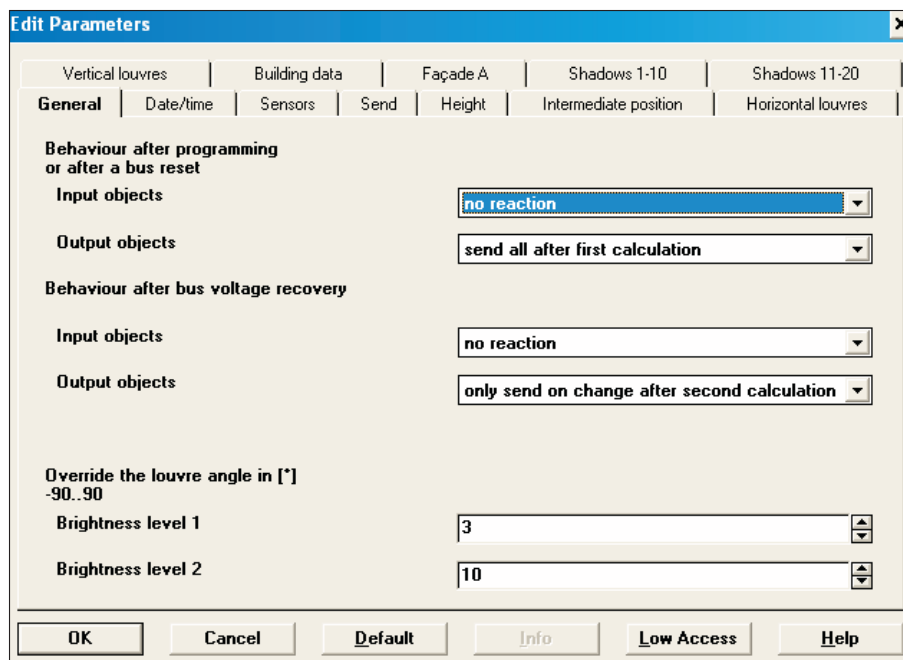

Fig. 29: Parameter window: "General"

Behaviour after programming or after a bus reset – Input objects

- Options:
- no reaction
 - query values via bus

It is set via this parameter whether the values of the input objects (brightness, date, time) should be queried via the EIB after programming or after a bus reset. If the option "no reaction" is selected, the value "0" remains in all the input objects until a telegram is received at the corresponding communication object.

Application program

Shutter Control /1

Behaviour after programming or after a bus reset –

Output objects

- Options:
- send all after first calculation
 - only send on change after second calculation

The output objects are recalculated (first calculation) after programming or after a bus reset. The output objects are always recalculated with the current time and then recalculated if the value of one of the input objects changes (second calculation).

It can be set via this parameter whether the output objects should send their value on the EIB after the first calculation. This option is advisable when the installation is commissioned for the first time.

If the option “only send on change after second calculation” is selected, the value is only sent after a recalculation if it deviates from the previously calculated value. This option is advisable in an installation in which only minor changes have been programmed.

Behaviour after bus voltage recovery –

Input objects

- Options:
- no reaction
 - query values via bus

It is set via this parameter whether the values of the input objects (brightness, date, time) should be queried via the EIB after a bus voltage recovery. If the option “no reaction” is selected, the value “0” remains in all the input objects until a telegram is received at the corresponding communication object.

Behaviour after bus voltage recovery –

Output objects

- Options:
- send all after initial calculation
 - only send on change after second calculation

The output objects are recalculated (first calculation) after programming or after a bus reset. The output objects are always recalculated with the current time and then recalculated if the value of one of the input objects changes (second calculation).

It can be set via this parameter whether the output objects should send their value on the EIB after the first calculation. This option is advisable when the installation is commissioned for the first time.

If the option “only send on change after second calculation” is selected, the value is only sent after a recalculation if it deviates from the previously calculated value. This option is advisable in an installation in which only minor changes have been programmed.

Override the louvre angle in [°]

- Options: – – 90...90

The louvre angle can be overridden via this parameter.

The parameterised value in degrees for the angle of the louvres is added to or subtracted from the calculated setpoint angle. The override can be set separately for both brightness levels.

4.1.2 Parameter window: "Date/time"

Fig. 30: Parameter window: "Date/time"

Operation mode for date/time

- Options:
- internal
 - slave (always receive)
 - master (send every minute)
 - master (send hourly)
 - master (send daily)

For setting the operation mode of the internal time switch. If the option "master (send hourly)" is selected, the parameter *Send hourly at [min.]* appears. If the option "master (send daily)" is selected, the parameters *Send daily at [h]* and *Send daily at [min.]* appear.



If a telegram is received at the "Date" communication object, the shutter control module first waits approx. 30 seconds to determine whether a telegram also arrives at the "Time" communication object. Only once this delay has elapsed is the internal clock set and the "Output" communication objects are recalculated.

Send hourly at [min.]

Send daily at [h]

Send daily at [min.]

Options [min.]: – 0...59

Options [h]: – 0...23

For setting the time when the date and time are sent via the EIB.

Time zone

- Options:
- UTC (Universal Coordinated Time)
 - Local time (summertime and wintertime)
 - Local time (standard time)

This parameter defines which time is used in the EIB installation. If the option “Local time (standard time)” is selected, the parameter *Time difference between local standard time and UTC* appears. If the option “Local time (summertime and wintertime)” is selected, the parameters *Time difference between local standard time and UTC* and *Time difference between summertime and standard time* appear.



A list with all time zones is to be found in chapter 5 (appendix).

Time difference between local standard time and UTC [h]

Options: – –11...12

For setting the time zone (time difference between the local standard time and UTC in hours). The time zone can be taken from the table in the appendix.

Time difference between summertime and standard time [h]

Options: – –2...2

For setting the time difference between summertime and local standard time in hours.

Daylight saving

Options: – European time change
– North American time change
– user-defined

The date for daylight saving is set via this parameter.

If the option “European time change” is selected, daylight saving is carried out on the last Sunday in March and the on the last Sunday in October. If the option “North American time change” is selected, the change is carried out on the first Sunday in April and on the first Sunday in October. If the option “user-defined” is selected, the parameter windows “Summer/winter 1/2” and “Summer/winter 3/4” appear.

4.1.3 Parameter window: “Summer/winter 1/2” or “Summer/winter 3/4”

This parameter is only visible if the option “user-defined” is set for the parameter *Daylight saving*. User-defined time changes can be parameterised for up to 4 years.

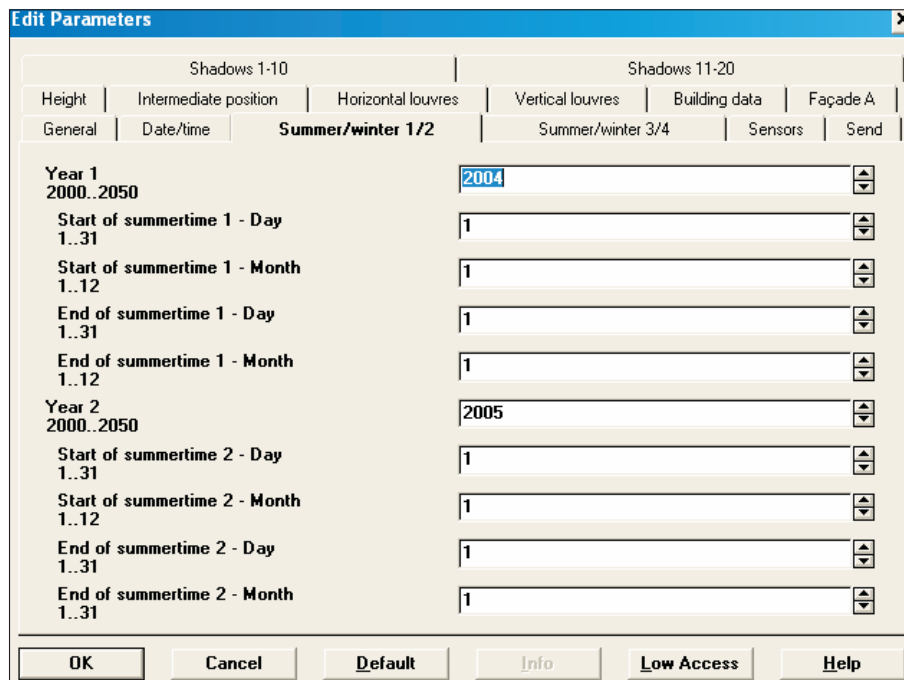

Fig. 31: Parameter window: “Summer/winter 1/2”

Year X

Options: – 2.000...2.050

For setting the year for which the daylight saving should be parameterised.

Start of summertime X - Day Start of summertime X - Month End of summertime X - Day End of summertime X - Month

Options for day: – 1...31

Options for month: – 1...12

For setting the day and month for the start and end of summertime.

4.1.4 Parameter window: "Sensors"

The following parameters can be set separately for both brightness levels.

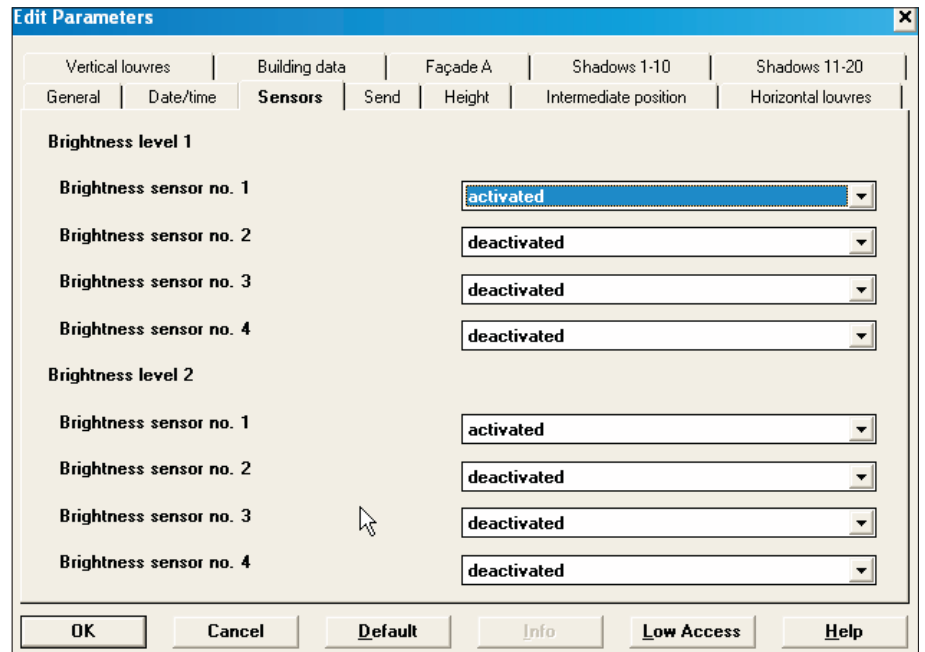

Fig. 32: Parameter window: "Sensors"

Brightness sensor no. 1
Brightness sensor no. 2
Brightness sensor no. 3
Brightness sensor no. 4
 Options: – activated
 – deactivated

The communication objects "Sensor no. X – Brightness" are activated or deactivated via these parameters. The values that are received at the brightness objects are linked with an OR function. The brightness sensor can be activated separately for both brightness levels.

For further information see also chapter 3.2.3 (Measuring the brightness).

4.1.5 Parameter window "Send"

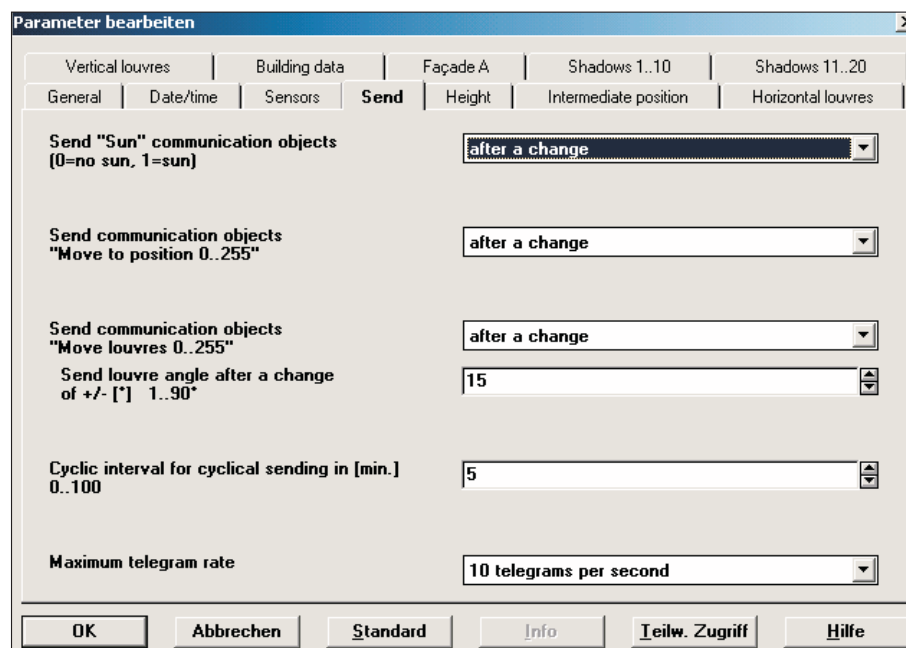

Fig. 33: Parameter window: "Send"

Send "Sun" communication objects

Options: – after a change
– cyclically

It is defined via this parameter whether the "Sun" communication objects are sent when the object value changes or cyclically.

If the option "cyclically" is selected, the object value is sent after a change in the value and once the cyclic interval has elapsed. The cyclic interval is set via the parameter *Cyclic interval for cyclical sending*.

Send communication objects "Move to position 0...255"

Options: – after a change
– cyclically

It is defined via this parameter whether the communication objects "Move to position 0...255" are sent when the object value changes or cyclically.

If the option "cyclically" is selected, the object value is sent after a change in the value and once the cyclic interval has elapsed. The cyclic interval is set via the parameter *Cyclic interval for cyclical sending*.

Send communication objects "Move louvres 0...255"

Options: – after a change
– cyclically

It is defined via this parameter whether the communication objects "Move louvres 0...255" are sent when the object value changes or cyclically.

If the option "cyclically" is selected, the object value is sent once the cyclic interval has elapsed. The cyclic interval is set via the parameter *Cyclic interval for cyclical sending*.

Unlike the two previous parameters, the object value is not additionally sent after a value change.

Application program Shutter Control /1

Send louvre angle after a change of

Options: – 1...90

It is defined via this parameter which change in the louvre angle should cause a telegram to be sent to the communication objects “Move louvres 0..255”. The angular variation is entered in degrees.

Cyclic interval for cyclical sending [min.]

Options: – 1...100

For setting the cyclic interval for cyclical sending in minutes.

Maximum telegram rate

Options: – 1/2/3/5/10/20 telegrams per second

For setting the maximum telegram rate.

4.1.6 Parameter window: “Height”

The following parameters can be set separately for both brightness levels.

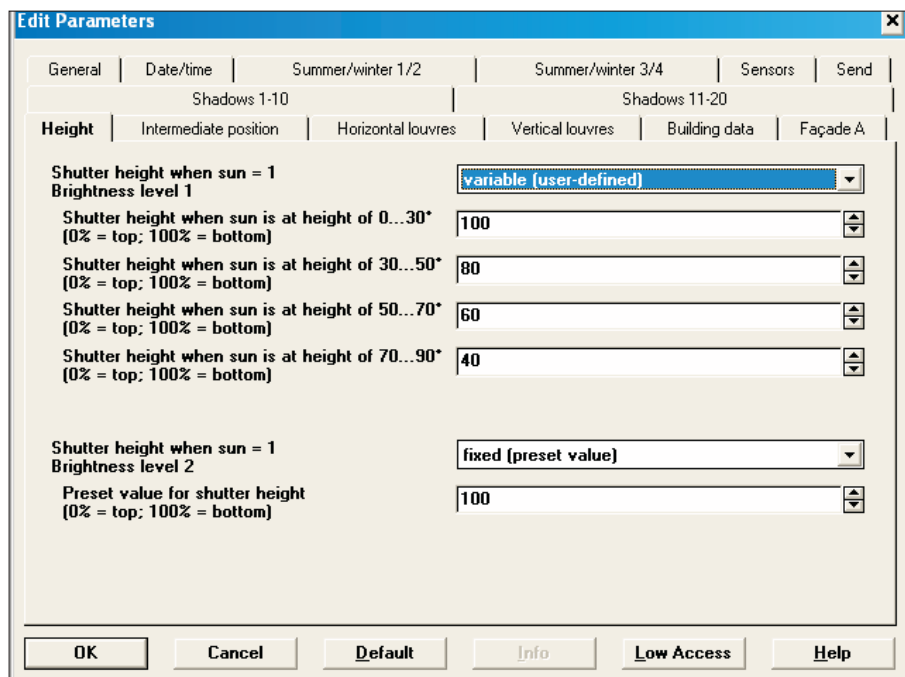

Fig. 34: Parameter window: “Height”

Shutter height when sun = 1

Options: – fixed (preset value)
– variable (standard movement)
– variable (user-defined)

It can be defined via this parameter which height the shutter should adopt when the sun is shining. If the option “fixed (preset value)” is selected, the parameter *Preset value for shutter height* appears. If the option “variable (user-defined)” is selected, the parameters *Shutter height when sun is at a height of* appear.

Application program

Shutter Control /1

If the option “variable (standard movement)” is selected, the movement of the shutter is controlled according to the calculated height of the sun in the following way (0% = top; 100%: bottom):

Height of sun	Height of shutter
0...30°	100% (closed)
30...50°	80%
50...70°	60%
70...90°	40%

Preset value for shutter height [%]

Options: – 0...100

To set the preset height of the shutter when the sun shines (0% = top; 100% = bottom).

Shutter height when sun is at height of 0...30° [%]

Shutter height when sun is at height of 30...50° [%]

Shutter height when sun is at height of 50...70° [%]

Shutter height when sun is at height of 70...90° [%]

Options: – 0...100

For setting the preset height of the shutter dependent on the position of the sun (0% = top; 100%: bottom).

4.1.7 Parameter window: “Intermediate position”

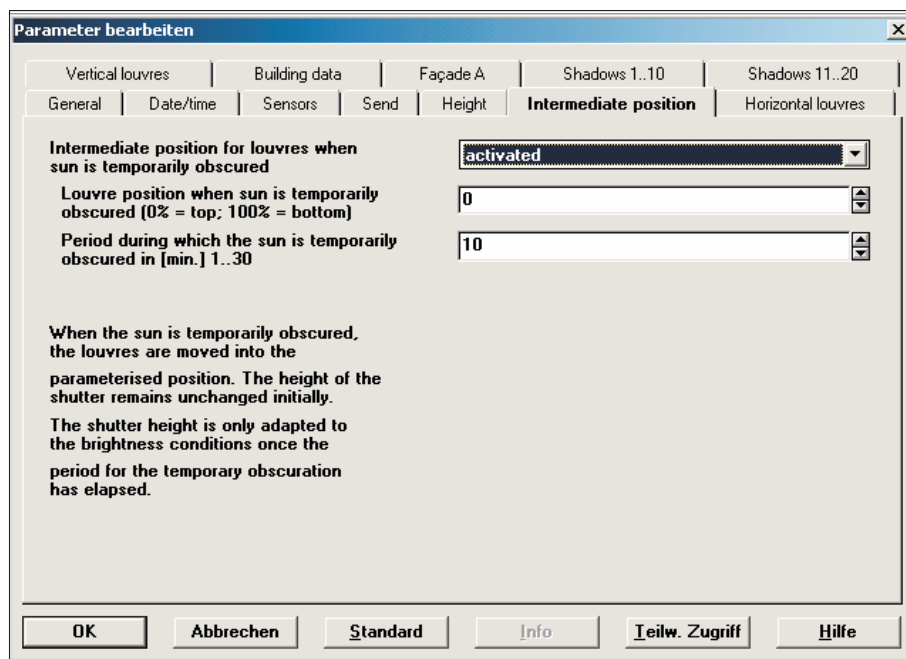

Fig. 35: Parameter window: “Intermediate position”

Intermediate position for louvres when sun is temporarily obscured

Options: – activated
– deactivated

To activate/deactivate the intermediate position when the sun is temporarily obscured (see chapter 3.2.4). If the option “activated” is set, the parameters *Louvre position when sun is temporarily obscured* and *Period during which the sun is temporarily obscured*.

Louvre position when sun is temporarily obscured

Options: – 0...100

To set the preset height of the shutter when the sun is temporarily obscured (0% louvres max. opened; 100% louvres max. closed).

Period during which the sun is temporarily obscured in [min.]

Options: – 1...30

For setting the duration of a temporary obscuration of the sun.

4.1.8 Parameter window: “Horizontal louvres”

The setting of the louvre data is described in chapter 3.3 (Geometry of the louvres).

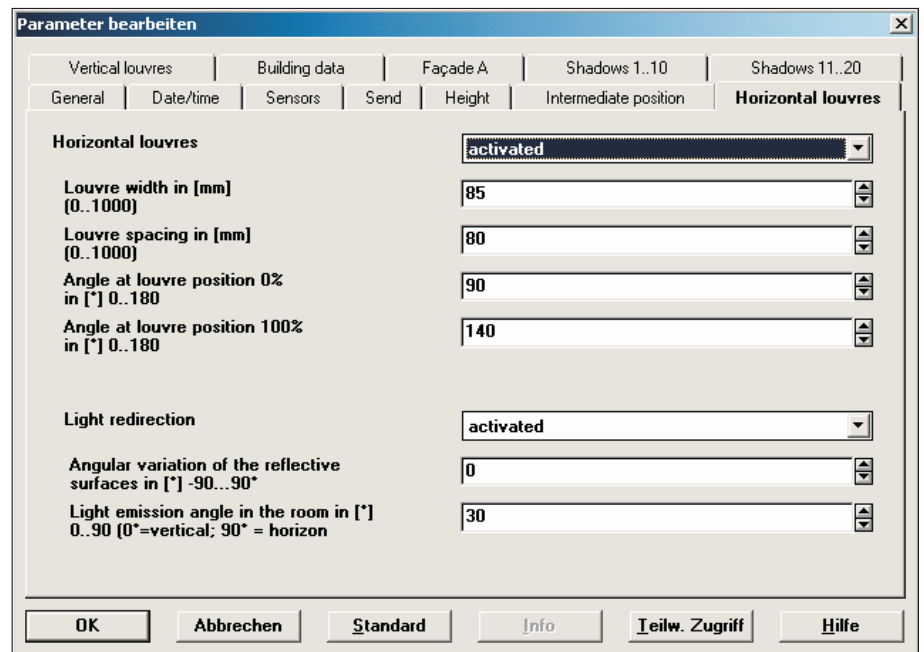

Fig. 36: Parameter window: “Horizontal louvres”

Horizontal louvres

Options: – activated
– deactivated

For setting the geometrical data of horizontal louvres. If the option “activated” is selected, the parameters *Louvre width*, *Louvre spacing*, *Angle at max. opening*, *Angle at max. closing* and *Light redirection* appear.

Louvre width in [mm]

Louvre spacing in [mm]

Options: – 0...1.000

For setting the louvre width and spacing for horizontal louvres in millimetres.

Application program

Shutter Control /1

Angle at louvre position 0 % in [°]
Angle at louvre position 100 % in [°]
Options: – 0...180

For setting the angle of the horizontal louvres in degrees when they are fully opened (0 %) or closed (100 %).

Light redirection
Options: – activated
– deactivated

For setting the geometrical data for horizontal louvres with reflective surfaces for light redirection. If the option “activated” is set, the parameters *Angular variation* and *Light emission angle* appear.

Angular variation of the reflective surfaces in [°]
Options: – – 90...90

For setting the angular variation between the reflective surface and the louvres in degrees.

Light emission angle in the room in [°]
Options: – – 90...90

For setting the required light emission angle in the room in degrees compared to the vertical.

4.1.9 Parameter window: "Vertical louvres"

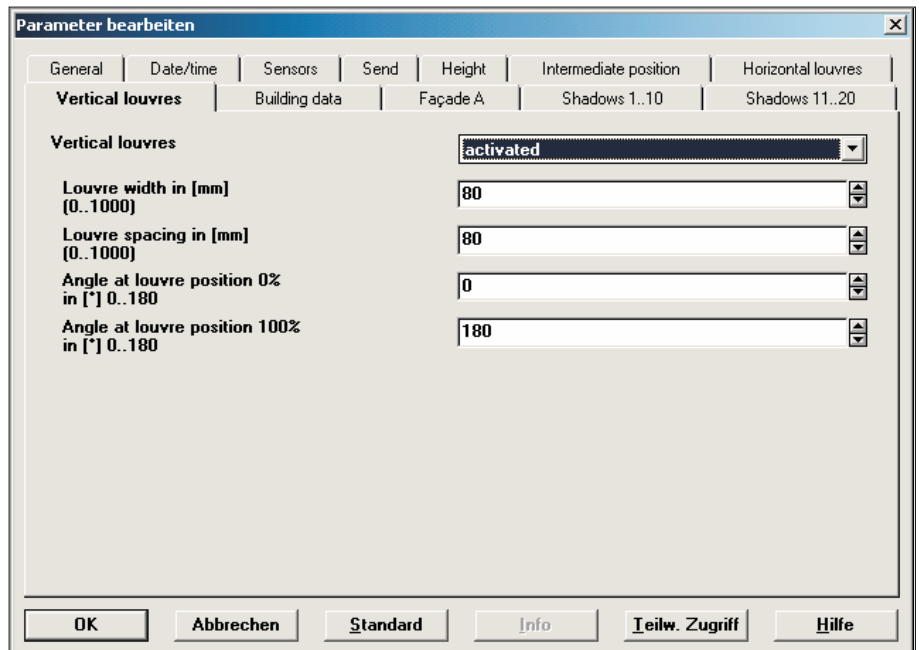

Fig. 37: Parameter window: "Vertical louvres"

Louvre width in [mm]
Louvre spacing in [mm]
 Options: – 0...1.000

For setting the louvre width and spacing for vertical louvres in millimetres.

Angle at louvre position 0 % in [°]
Angle at louvre position 100 % in [°]
 Options: – 0...180

For setting the angle of the vertical louvres in degrees when they are fully opened (0 %) or closed (100 %) compared to the horizontal.

4.1.10 Parameter window: "Building data"

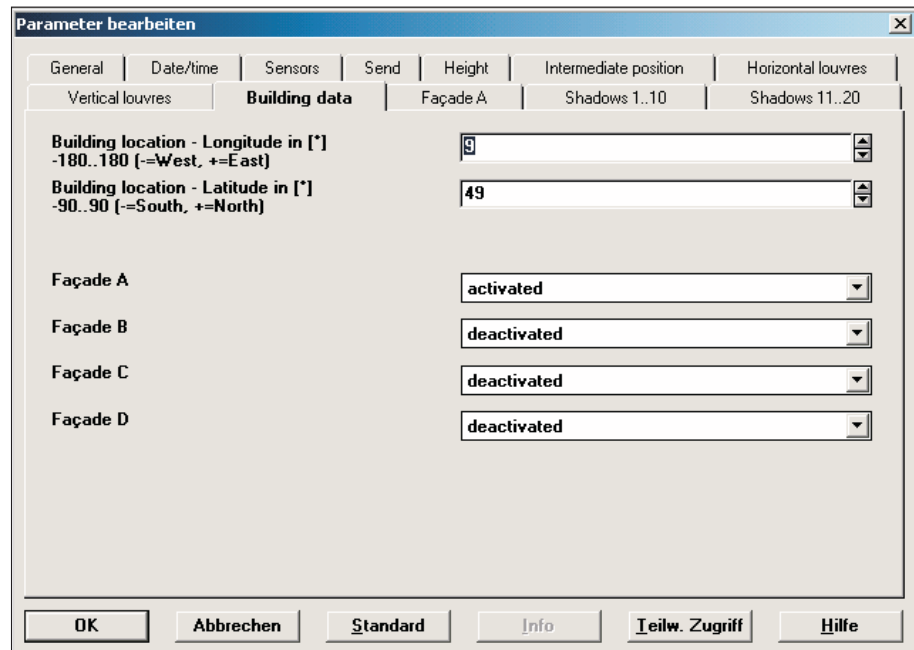

Fig. 38: Parameter window: "Building data"

Building location - Longitude in [°]

Building location - Latitude in [°]

Options for latitude [°]: -- 180...180

Options for longitude [°]: -- 90...90

For setting the location of the building. The degrees of latitude and longitude are entered in degrees and minutes (see also chapter 3.2.2).

Façade A

Façade B

Façade C

Façade D

Options: – activated
– deactivated

Via these parameters, the parameter windows "Façade X" and the communication objects "Façade X – Sun", "Façade X – Move to position 0...255" and "Façade X – Move louvres 0...255" are activated or deactivated.

4.1.11 Parameter window: “Façade A”

This parameter window is only visible if the option “activated” has been set for the parameter Façade A. The parameterisation of façades B, C and D is carried out in the same way. The setting of the parameters is described in chapter 3.2.2.

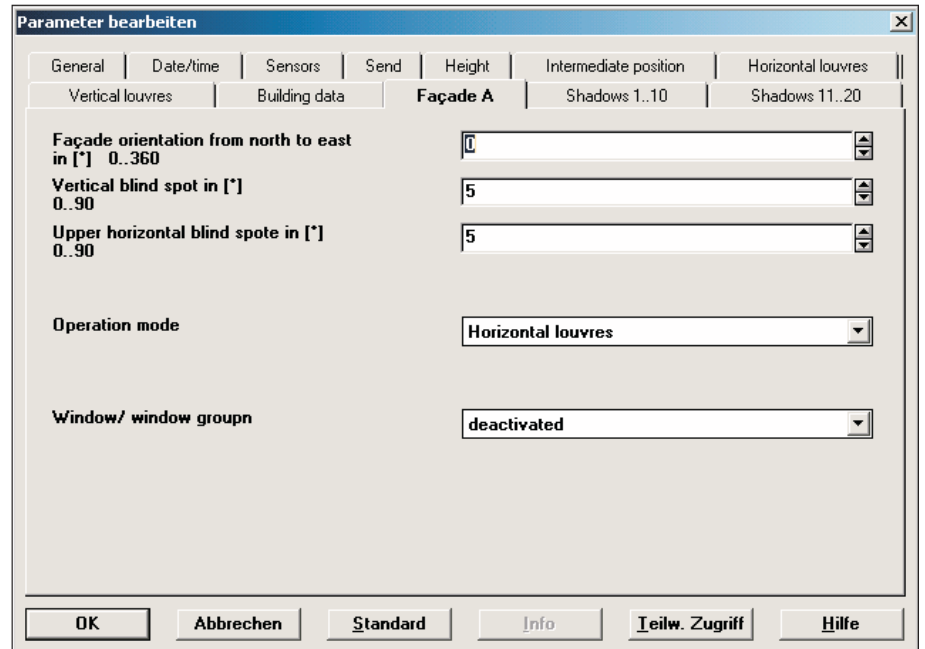

Fig. 39: Parameter window: “Façade A”

Façade orientation in [°]

Options for degree of latitude: – 0...360

For setting the façade orientation in degrees compared to the north-south axis.

Vertical blind spot in [°]

Upper horizontal blind spot in [°]

Options: – 0...90

For setting the vertical and upper horizontal blind spot in degrees.

Operation mode

Options: – horizontal louvres
– horizontal louvres with light redirection
– vertical louvres

For setting the type of shutter that should be controlled for the relevant façade.

Windows/window groups

Options: – deactivated
– as a grid
– user-defined

It is set via this parameter whether façade A is controlled uniformly (window/window groups “deactivated”) or whether each window or window group is set individually via a grid system or user-defined.

If the option “as a grid” is selected, the parameter “Grid dimensions” appears as well as the parameter window “A: Grid system” and the communication objects “Façade A: Floor X, window X – Sun”. If the option “user-defined” is selected, the parameter windows “A: Groups” appear.

4.1.12 Parameter window: “A: Grid system”

This parameter window is only visible if the option “as a grid” has been set for the parameter *Windows/window groups*. The parameterisation of the window grid is carried out in the same way for façades B, C and D.

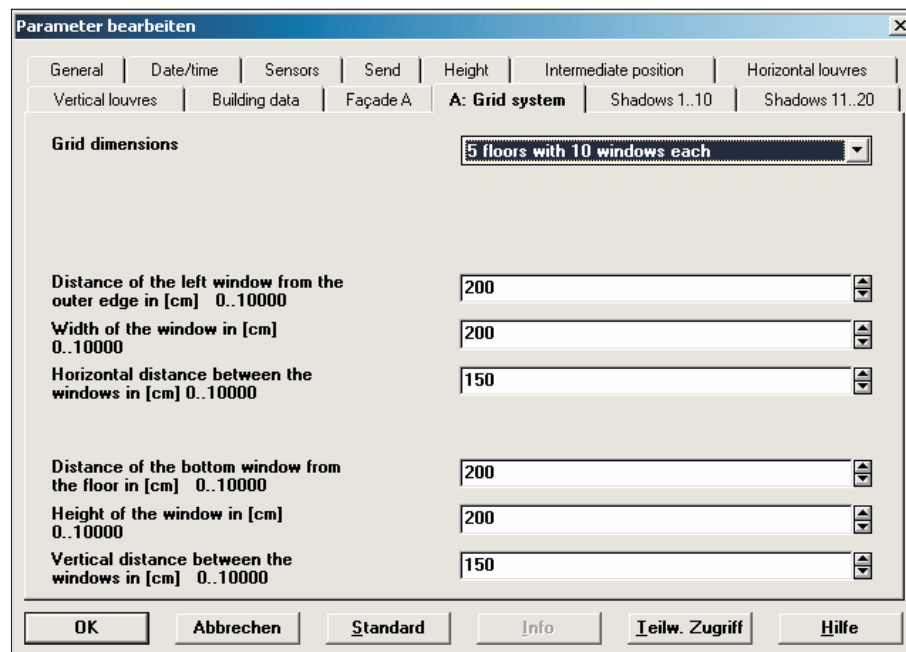

Fig. 40: Parameter window: “A: Grid system”

Grid dimensions

- Options:
- 1 floor with 50 windows
 - 2 floors with 25 windows each
 - 5 floors with 10 windows each
 - 10 floors with 5 windows each
 - 25 floors with 2 windows each
 - 50 floors with 1 window each

For selection of the grid dimensions. Depending on the selected option, the designation of the communication objects “Façade X: X floor, window X – Sun” changes.

Distance of the left window from the outer edge in [cm]

Width of the window in [cm]

Horizontal distance between the windows in [cm]

Distance of the bottom window from the floor in [cm]

Height of the window in [cm]

Vertical distance between the windows in [cm]

- Options: – 0...10.000

For setting the window grid for façade A in centimetres (see chapter 3.4.2).

4.1.13 Parameter window: “A: Groups”

This parameter is only visible if the option “user-defined” has been set for the parameter *Windows/window groups*. The parameterisation of the window groups is carried out in the same way for façades B, C and D.

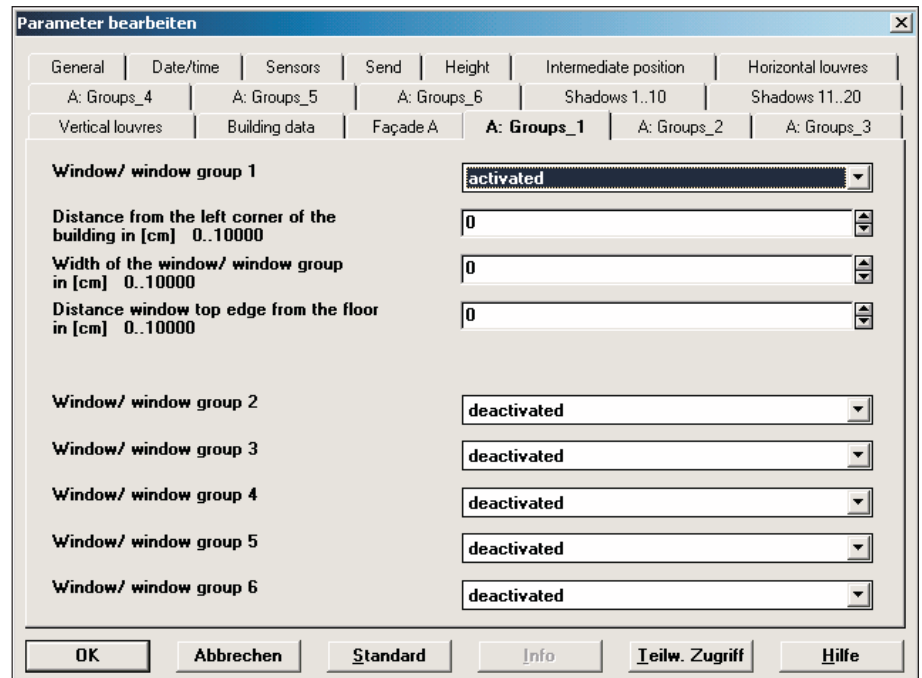

Fig. 41: Parameter window: “A: Groups”

Window/window group 1 Window/window group 2 etc.

Options: – activated
– deactivated

The parameters “Distance from the left corner of the building”, “Width of the window/window group” and “Distance from the floor” are shown separately for each window group.

Distance from the left corner of the building in [cm] Width of the window/window group in [cm] Distance window top edge from the floor in [cm]

Options: – 0...10.000

For setting the layout of the windows on façade A in centimetres (see chapter 3.4.2).

**4.1.14 Parameter window:
“Shadows 1–10” or
“Shadows 11–20”**

Fig. 42: Parameter window: “Shadows 1–10”

Shadow object 1**Shadow object 2**

...

Shadow object 10Options: – activated
 – deactivated

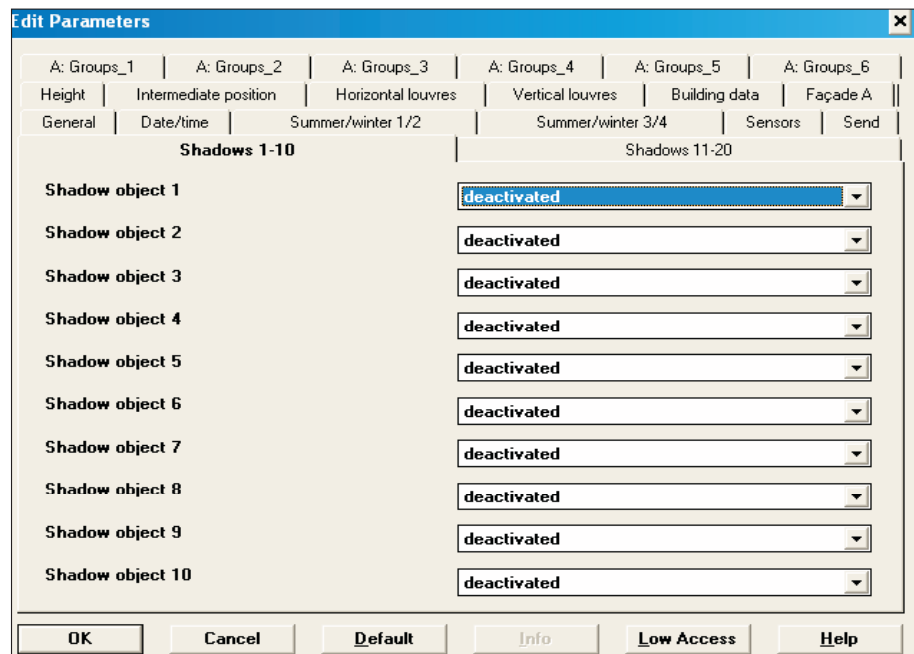
If the option “activated” is selected, the parameter window “Shadow X” appears.

4.1.15 Parameter window: “Shadow 1”

This parameter is only visible if the option “activated” has been selected for the parameter *Shadow object 1*. The parameterisation of the other shadow objects is carried out in the same way.

Fig. 43: Parameter window: “Shadow 1”

Shape of the shadow object

Options: – rectangle
– circle

For setting the shape of the shadow object.

Position X1 in [0.1 m]

Position Y1 in [0.1 m]

Position X2 in [0.1 m]

Position Y2 in [0.1 m]

Depth in [0.1 m]

Central point X in [0.1 m]

Central point Y in [0.1 m]

Diameter in [m]

Height in [0.1 m]

Options for height and depth: – 0...1000

Other options: – –1000...1000

For setting the position and height of the shadow object in metres (see chapter 3.4.3).



Y1 and Y2 must be chosen in that way, that the parameter values are different from each other (see planning example in chapter 3.4.5).

Shadow object influences

Options: – Façade A
– Façade B
– Façade C
– Façade D

It is set via this parameter which façade is influenced by the object casting a shadow.

Shadow is cast from
Shadow is cast until
Options: – January
 – February
 – ...
 – December

This parameter determines during which months the object casts a shadow. It is therefore possible for example to take into account the various periods when trees come into leaf.

4.2 Communication objects

4.2.1 “Input” communication objects

no.	Object name	Function	C	R	W	T	U	Type
4	Sensor no. 1	Brightness - Level 1	✓	✓	✓			1 Bit
5	Sensor no. 2	Brightness - Level 1	✓	✓	✓			1 Bit
6	Sensor no. 3	Brightness - Level 1	✓	✓	✓			1 Bit
7	Sensor no. 4	Brightness - Level 1	✓	✓	✓			1 Bit
8	Sensor no. 1	Brightness - Level 2	✓	✓	✓			1 Bit
9	Sensor no. 2	Brightness - Level 2	✓	✓	✓			1 Bit
10	Sensor no. 3	Brightness - Level 2	✓	✓	✓			1 Bit
11	Sensor no. 4	Brightness - Level 2	✓	✓	✓			1 Bit

Fig. 44: “Input” communication objects

- Sensor no. 1 – Brightness - Level 1 (EIS 1: 1 Bit)**
- Sensor no. 2 – Brightness - Level 1 (EIS 1: 1 Bit)**
- Sensor no. 3 – Brightness - Level 1 (EIS 1: 1 Bit)**
- Sensor no. 4 – Brightness - Level 1 (EIS 1: 1 Bit)**
- Sensor no. 1 – Brightness - Level 2 (EIS 1: 1 Bit)**
- Sensor no. 2 – Brightness - Level 2 (EIS 1: 1 Bit)**
- Sensor no. 3 – Brightness - Level 2 (EIS 1: 1 Bit)**
- Sensor no. 4 – Brightness - Level 2 (EIS 1: 1 Bit)**

The shutter control module receives the information at this communication object as to whether the sunlight exceeds the set threshold value. Up to four brightness communication objects can be activated for each of the two brightness levels. The received values are assigned an OR function.

Telegram value: “0”: Value falls below threshold (no sun)
 “1”: Value exceeds threshold (sun)

4.2.2 “Output” communication objects

Nr.	Objektname	Funktion	K	L	S	Ü	Akt	Typ
12	Façade A	Move to position 0..255	✓	✓		✓		1 Byte
13	Façade A	Move louvres 0..255	✓	✓		✓		1 Byte
14	Façade A	Sun	✓	✓		✓		1 Bit
15	Façade A - 1st floor, window 1	Sun	✓	✓		✓		1 Bit
16	Façade A - 1st floor, window 2	Sun	✓	✓		✓		1 Bit

Fig. 45: “Output” communication objects for grid programming

Nr.	Objektname	Funktion	K	L	S	Ü	Akt	Typ
12	Façade A	Move to position 0..255	✓	✓		✓		1 Byte
13	Façade A	Move louvres 0..255	✓	✓		✓		1 Byte
14	Façade A	Sun	✓	✓		✓		1 Bit
15	Façade A - window 1	Sun	✓	✓		✓		1 Bit
16	Façade A - window 2	Sun	✓	✓		✓		1 Bit

Fig. 46: “Output” communication objects for user-defined programming

Application program

Shutter Control /1

Façade A – Move to position 0...255 (EIS 6: 8 bit)

The height of the shutter which is determined by tracking the position of the sun is sent via this communication object. The height applies to all the shutters of façade A, regardless of whether they are controlled together, in groups or individually.

Telegram value:	“0”:	Top
	“...”:	Intermediate position
	“255”:	Bottom

Façade A – Move louvres 0...255 (EIS 6: 8 bit)

The louvre position which is determined by tracking the position of the sun is sent via this communication object. The louvre position applies to all the shutters of façade A, regardless of whether they are controlled together, in groups or individually.

Telegram value:	“0”:	Louvres fully opened
	“...”:	Intermediate position
	“255”:	Louvres closed

Façade A – Sun (EIS 1: 1 bit)

The information as to whether the sun is shining on façade A is sent via this communication object. A “1” is sent if the sun is shining on façade A. A “0” is sent if the sun is not shining on façade A or is not shining at all.

All the shutters of a façade are controlled in the same way via this communication object.

Telegram value:	“0”:	Sun is not shining on façade A
	“1”:	Sun is shining on façade A

Façade A: 1st floor, window 1 – Sun (EIS 1: 1 bit)

Façade A: 1st floor, window 2 – Sun (EIS 1: 1 bit)

etc.

These communication objects are only visible if the option “as a grid” has been set for the parameter *Windows/window groups*.

The information as to whether the sun is shining on the relevant window is sent via this communication object. A “1” is sent if the sun is shining on the window. A “0” is sent if the sun is not shining or if the window is shaded.

The shutter for the relevant window is controlled individually via this communication object.

Telegram value:	“0”:	Sun is not shining on window
	“1”:	Sun is shining on window

Application program Shutter Control /1

Façade A: Window 1 – Sun (EIS 1: 1 bit)

Façade A: Window 2 – Sun (EIS 1: 1 bit)

etc.

These communication objects are only visible if the option “user-defined” has been set for the parameter *Windows/window groups*.

The information as to whether the sun is shining on the relevant window is sent via this communication object. A “1” is sent if the sun is shining on the window. A “0” is sent if the sun is not shining on the window or is not shining at all.

It is possible to control a single window individually or a group of windows via this communication object.

Telegram value: “0”: Sun is not shining on window group
 “1”: Sun is shining on window group

4.2.3 “Date/time” communication objects





no.	Object name	Function	C	R	W	T	U	Type
 0	Input date	Input date		✓		✓	✓	3 Byte
 1	Input time	Input time		✓		✓	✓	3 Byte
 2	Output date	Output date	✓	✓			✓	3 Byte
 3	Output time	Output time	✓	✓			✓	3 Byte

Fig. 47: “Date/time” communication objects

Input date (EIS 4: 3 byte)

Input time (EIS 3: 3 byte)

The date and time are received at these communication objects. Each time a telegram is received at one of these communication objects, the internal clock is reset. At the same time, all the “Output” communication objects are recalculated and if necessary send their new value.

If a telegram is received at the “Date” communication object, the shutter control module first waits approx. 30 seconds to determine whether a telegram also arrives at the “Time” communication object. Only once this delay has elapsed is the internal clock set and the “Output” communication objects are recalculated.

These communication objects can be used to operate the shutter control module as a slave clock in the EIB installation or to load the date and time into the shutter control module during commissioning.

Output date (EIS 4: 3 byte)

Output time (EIS 3: 3 byte)

These communication objects are only visible if the parameter *Operation mode for date/time* has been set to “master ...”.

The shutter control module sends the current date and time via these communication objects at the time specified in the parameters.

5 Appendix

5.1 Time zones

Afghanistan	UTC + 4.5 hrs	Cyprus	UTC + 2 hrs
Albania	UTC + 1 hr	Cyprus (Turkish/Cypriot area)	UTC + 2 hrs
Algeria	UTC + 1 hr	Czech Republic	UTC + 1 hr
American Virgin Islands	UTC - 4 hrs	Denmark	UTC + 1 hr
Angola	UTC + 1 hr	Djibouti	UTC + 3 hrs
Anguilla	UTC - 4 hrs	Dominican Republic	UTC - 4 hrs
Antigua and Barbuda	UTC - 4 hrs	Ecuador	UTC - 5 hrs
Argentina	UTC - 3 hrs	Egypt	UTC + 2 hrs
Armenia	UTC + 3 hrs	El Salvador	UTC - 6 hrs
Aruba	UTC - 4 hrs	Equatorial New Guinea	UTC + 1 hr
Australia		Eritrea	UTC + 3 hrs
Western Australia	UTC + 8 hrs	Estonia	UTC + 2 hrs
Northern Territory	UTC + 9.5 hrs	Ethiopia	UTC + 3 hrs
South Australia	UTC + 9.5 hrs	Fiji	UTC + 12 hrs
Queensland	UTC + 10 hrs	Finland	UTC + 2 hrs
New South Wales	UTC + 10 hrs	France	UTC + 1 hr
Australian Capital Territory	UTC + 10 hrs	Gabon	UTC + 1 hr
Victoria	UTC + 10 hrs	Gambia	UTC
Tasmania	UTC + 10 hrs	Georgia	UTC + 4 hrs
Austria	UTC + 1 hr	Germany	UTC + 1 hr
Azerbaijan	UTC + 4 hrs	Ghana	UTC
Bahamas	UTC - 5 hrs	Grenada	UTC - 4 hrs
Bahrain	UTC + 3 hrs	Greece	UTC + 2 hrs
Bangladesh	UTC + 6 hrs	Great Britain	UTC
Barbados	UTC - 4 hrs	Guatemala	UTC - 6 hrs
Belarus	UTC + 2 hrs	Guinea	UTC
Belgium	UTC + 1 hr	Guinea-Bissau	UTC
Benin	UTC + 1 hr	Guyana	UTC - 3 hrs
Bermuda	UTC - 4 hrs	Haiti	UTC - 5 hrs
Bolivia	UTC - 4 hrs	Honduras	UTC - 6 hrs
Bosnia and Herzegovina	UTC + 1 hr	Hong Kong, SVC	UTC + 8 hrs
Botswana	UTC + 2 hrs	Hungary	UTC + 1 hr
Brazil		Iceland	UTC
Western Brazil	UTC - 5 hrs	India	UTC + 5.5 hrs
Central Brazil	UTC - 4 hrs	Indonesia	
Costal states incl. Minas Gerais, Goias and main city	UTC - 3 hrs	Western	UTC + 7 hrs
British Virgin Islands	UTC + 4 hrs	Northern and Central	UTC + 8 hrs
Brunei Darussalam	UTC + 9 hrs	Eastern	UTC + 9 hrs
Bulgaria	UTC + 2 hrs	Iran	UTC + 3.5 hrs
Burkina Faso	UTC	Ireland	UTC
Burundi	UTC + 2 hrs	Israel	UTC + 2 hrs
Cayman Islands	UTC - 5 hrs	Italy	UTC + 1 hr
Cambodia	UTC + 7 hrs	Ivory Coast	UTC
Cameroon	UTC + 1 hr	Jamaica	UTC - 5 hrs
Canada		Japan	UTC + 9 hrs
Pacific Standard Time	UTC - 8 hrs	Jordan	UTC + 2 hrs
Mountain Standard Time	UTC - 7 hrs	Kazakhstan	
Central Standard Time	UTC - 6 hrs	Western Kazakhstan	UTC + 5 hrs
Eastern Standard Time	UTC - 5 hrs	Eastern Kazakhstan	UTC + 6 hrs
Atlantic Standard Time	UTC - 4 hrs	Kenya	UTC + 3 hrs
Newfoundland	UTC - 3.5 hrs	Korea (Dem.)	UTC + 9 hrs
Cap Verde	UTC - 1 hr	Korea (Rep.)	UTC + 9 hrs
Central African Republic	UTC + 1 hr	Kuwait	UTC + 3 hrs
Chad	UTC + 1 hr	Kyrgyzstan	UTC + 5 hrs
Chile	UTC - 4 hrs	Laos	UTC + 7 hrs
PR China	UTC + 8 hrs	Latvia	UTC + 2 hrs
Columbia	UTC - 5 hrs	Lebanon	UTC + 2 hrs
Comoros	UTC + 3 hrs	Lesotho	UTC + 2 hrs
Congo (Dem. Rep.)		Liberia	UTC
East	UTC + 2 hrs	Libya	UTC + 2 hrs
West	UTC + 1 hr	Liechtenstein	UTC + 1 hr
Congo (PR)	UTC + 1 hr	Lithuania	UTC + 1 hr
Costa Rica	UTC - 6 hrs	Luxembourg	UTC + 1 hr
Croatia	UTC + 1 hr	Macau	UTC + 8 hrs
Cuba	UTC - 5 hrs	Macedonia	UTC + 1 hr
Curaçao	UTC - 4 hrs	Madagascar	UTC + 3 hrs
		Malawi	UTC + 2 hrs
		Malaysia	UTC + 8 hrs
		Mali	UTC

Malta	UTC + 1 hr	Switzerland	UTC + 1 hr
Mauritania	UTC	Syria	UTC + 2 hrs
Mauritius	UTC + 4 hrs	Tajikistan	UTC + 5 hrs
Mexico		Taiwan	UTC + 8 hrs
Quintana Roo	UTC - 5 hrs	Tanzania	UTC + 3 hrs
Baja California Norte	UTC - 6 hrs	Thailand	UTC + 7 hrs
Baja California Sur	UTC - 7 hrs	Togo	UTC
Sonora	UTC - 7 hrs	Trinidad and Tobago	UTC - 4 hrs
Sinaola	UTC - 7 hrs	Tunisia	UTC + 1 hr
Nayarit	UTC - 7 hrs	Turkey	UTC + 2 hrs
Central and Western Mexico	UTC - 8 hrs	Turkmenistan	UTC + 5 hrs
Moldavia	UTC + 2 hrs	Uganda	UTC + 3 hrs
Mongolia		Ukraine	UTC + 2 hrs
Western Mongolia	UTC + 7 hrs	United Arab Emirates	UTC + 4 hrs
Central Mongolia	UTC + 8 hrs	Uruguay	UTC - 3 hrs
Eastern Mongolia	UTC + 9 hrs	USA	
Montserrat	UTC - 4 hrs	Hawaii-Aleutian Standard Time	UTC - 10 hrs
Morocco	UTC	Alaska Standard Time	UTC - 9 hrs
Mozambique	UTC + 2 hrs	Pacific Standard Time	UTC - 8 hrs
Myanmar	UTC + 6.5 hrs	Mountain Standard Time	UTC - 7 hrs
Namibia	UTC + 2 hrs	Central Standard Time	UTC - 6 hrs
Nepal	UTC + 5.75 hrs	Eastern Standard Time	UTC - 5 hrs
Netherlands	UTC + 1 hr	Atlantic Standard Time	UTC - 4 hrs
New Zealand	UTC + 12 hrs	Uzbekistan	UTC + 5 hrs
Nicaragua	UTC - 6 hrs	Venezuela	UTC - 4 hrs
Niger	UTC + 1 hr	Vietnam	UTC + 7 hrs
Nigeria	UTC + 1 hr	Yemen	UTC + 3 hrs
Norway	UTC + 1 hr	Yugoslavia	UTC + 1 hr
Oman	UTC + 4 hrs	Zambia	UTC + 2 hrs
Pakistan	UTC + 5 hrs	Zimbabwe	UTC + 2 hrs
Palestinian areas	UTC + 2 hrs		
Panama	UTC - 5 hrs		
Papua New Guinea	UTC + 10 hrs		
Paraguay	UTC - 4 hrs		
Peru	UTC - 5 hrs		
Philippines	UTC + 8 hrs		
Poland	UTC + 1 hr		
Portugal	UTC		
Puerto Rico	UTC - 4 hrs		
Qatar	UTC + 3 hr		
Réunion	UTC + 4 hrs		
Rumania	UTC + 2 hrs		
Russia			
European quarter	UTC + 3 hrs		
Smaller areas on the central Volga	UTC + 4 hrs		
Ural region and parts of Western Siberia	UTC + 5 hrs		
Western Siberia and parts of Central Siberia	UTC + 6 hrs		
Parts of Central Siberia	UTC + 7 hrs		
Parts of Eastern Siberia	UTC + 8 hrs		
Parts of Eastern Siberia and parts of Far East	UTC + 9 hrs		
Parts of the Far East	UTC + 10 hrs		
Parts of the Far East	UTC + 11 hrs		
Parts of the Far East	UTC + 12 hrs		
Rwanda	UTC + 2 hrs		
Saudi Arabia	UTC + 3 hrs		
Senegal	UTC		
Seychelles	UTC + 4 hrs		
Sierra Leone	UTC		
Singapore	UTC + 8 hrs		
Slovak Republic	UTC + 1 hr		
Slovenia	UTC + 1 hr		
Somalia	UTC + 3 hrs		
South Africa	UTC + 2 hrs		
Spain	UTC + 1 hr		
Sri Lanka	UTC + 5.5 hrs		
St. Kitts and Nevis	UTC - 4 hrs		
St. Lucia	UTC - 4 hrs		
St. Vincent and Grenada	UTC - 4 hrs		
Sudan	UTC + 2 hrs		
Suriname	UTC - 3.5 hrs		
Swaziland	UTC + 2 hrs		
Sweden	UTC + 1 hr		

5.2 Planning checklist

For a rapid parameterisation of the shutter control unit JSB/S 1.1, you should determine the following data in the preliminary stages and fill in the parameter fields. Chapter 3 (Application and planning) contains practical tips for determining geometrical parameters:

Project without shadow objects

Brightness levels, override and shutter height

Brightness level 1, number of brightness sensors: _____

Override: _____ °

Shutter height: fixed: _____ %

user-defined: Height of sun Height of shutter

0...30°	_____ %
30...50°	_____ %
50...70°	_____ %
70...90°	_____ %

Brightness level 2, number of brightness sensors: _____

Override: _____ °

Shutter height: fixed: _____ %

user-defined: Height of sun Height of shutter

0...30°	_____ %
30...50°	_____ %
50...70°	_____ %
70...90°	_____ %

Intermediate position when sun is temporarily obscured

Louvre position when sun is temporarily obscured: _____ %

Period during which the sun is temporarily obscured: _____ minutes

Louvre geometry

Horizontal louvres

Louvre width: _____ mm Louvre spacing: _____ mm

Angle at max. opening (0 %): _____ ° Angle at max. closing (100 %): _____ °

Light redirection

Angular variation of the reflective surface: _____ °

Light emission angle in the room: _____ °

Vertical louvres

Louvre width: _____ mm Louvre spacing: _____ mm

Angle at max. opening (0 %): _____ ° Angle at max. closing (100 %): _____ °

Building data

Building location: Latitude: _____ ° Longitude: _____ °

Façade A Façade orientation: _____ °

Façade B Façade orientation: _____ °

Façade C Façade orientation: _____ °

Façade D Façade orientation: _____ °

Shadow objects

The following parameters must only be parameterised for projects with shadow objects. The following page can be copied and further copies can be made to the number of user-defined window groups.

Shadow objects

- 1 rectangle/ circle
 X1/ X: ____ m Y1/Y: ____ m X2: ____ m Y2: ____ m
 Depth: ____ m Height: ____ m
 Influences: Façade A/ Façade B/ Façade C/ Façade D
 Effective from: _____ to: _____
- 2 rectangle/ circle
 X1/ X: ____ m Y1/Y: ____ m X2: ____ m Y2: ____ m
 Depth: ____ m Height: ____ m
 influences: Façade A/ Façade B/ Façade C/ Façade D
 Effective from: _____ to: _____
- 3 rectangle/ circle
 X1/ X: ____ m Y1/Y: ____ m X2: ____ m Y2: ____ m
 Depth: ____ m Height: ____ m
 Influences: Façade A/ Façade B/ Façade C/ Façade D
 Effective from: _____ to: _____
- 4 rectangle/ circle
 X1/ X: ____ m Y1/Y: ____ m X2: ____ m Y2: ____ m
 Depth: ____ m Height: ____ m
 Influences: Façade A/ Façade B/ Façade C/ Façade D
 Effective from: _____ to: _____
- 5 rectangle/ circle
 X1/ X: ____ m Y1/Y: ____ m X2: ____ m Y2: ____ m
 Depth: ____ m Height: ____ m
 Influences: Façade A/ Façade B/ Façade C/ Façade D
 Effective from: _____ to: _____
- 6 rectangle/ circle
 X1/ X: ____ m Y1/Y: ____ m X2: ____ m Y2: ____ m
 Depth: ____ m Height: ____ m
 Influences: Façade A/ Façade B/ Façade C/ Façade D
 Effective from: _____ to: _____
- 7 rectangle/ circle
 X1/ X: ____ m Y1/Y: ____ m X2: ____ m Y2: ____ m
 Depth: ____ m Height: ____ m
 Influences: Façade A/ Façade B/ Façade C/ Façade D
 Effective from: _____ to: _____
- 8 rectangle/ circle
 X1/ X: ____ m Y1/Y: ____ m X2: ____ m Y2: ____ m
 Depth: ____ m Height: ____ m
 Influences: Façade A/ Façade B/ Façade C/ Façade D
 Effective from: _____ to: _____
- 9 rectangle/ circle
 X1/ X: ____ m Y1/Y: ____ m X2: ____ m Y2: ____ m
 Depth: ____ m Height: ____ m
 Influences: Façade A/ Façade B/ Façade C/ Façade D
 Effective from: _____ to: _____
- 10 rectangle/ circle
 X1/ X: ____ m Y1/Y: ____ m X2: ____ m Y2: ____ m
 Depth: ____ m Height: ____ m
 Influences: Façade A/ Façade B/ Façade C/ Façade D
 Effective from: _____ to: _____

- 11 rectangle/ circle
 X1/ X: _____ m Y1/Y: _____ m X2: _____ m Y2: _____ m
 Depth: _____ m Height: _____ m
 Influences: Façade A/ Façade B/ Façade C/ Façade D
 Effective from: _____ to: _____
- 12 rectangle/ circle
 X1/ X: _____ m Y1/Y: _____ m X2: _____ m Y2: _____ m
 Depth: _____ m Height: _____ m
 Influences: Façade A/ Façade B/ Façade C/ Façade D
 Effective from: _____ to: _____
- 13 rectangle/ circle
 X1/ X: _____ m Y1/Y: _____ m X2: _____ m Y2: _____ m
 Depth: _____ m Height: _____ m
 Influences: Façade A/ Façade B/ Façade C/ Façade D
 Effective from: _____ to: _____
- 14 rectangle/ circle
 X1/ X: _____ m Y1/Y: _____ m X2: _____ m Y2: _____ m
 Depth: _____ m Height: _____ m
 Influences: Façade A/ Façade B/ Façade C/ Façade D
 Effective from: _____ to: _____
- 15 rectangle/ circle
 X1/ X: _____ m Y1/Y: _____ m X2: _____ m Y2: _____ m
 Depth: _____ m Height: _____ m
 Influences: Façade A/ Façade B/ Façade C/ Façade D
 Effective from: _____ to: _____
- 16 rectangle/ circle
 X1/ X: _____ m Y1/Y: _____ m X2: _____ m Y2: _____ m
 Depth: _____ m Height: _____ m
 Influences: Façade A/ Façade B/ Façade C/ Façade D
 Effective from: _____ to: _____
- 17 rectangle/ circle
 X1/ X: _____ m Y1/Y: _____ m X2: _____ m Y2: _____ m
 Depth: _____ m Height: _____ m
 Influences: Façade A/ Façade B/ Façade C/ Façade D
 Effective from: _____ to: _____
- 18 rectangle/ circle
 X1/ X: _____ m Y1/Y: _____ m X2: _____ m Y2: _____ m
 Depth: _____ m Height: _____ m
 Influences: Façade A/ Façade B/ Façade C/ Façade D
 Effective from: _____ to: _____
- 19 rectangle/ circle
 X1/ X: _____ m Y1/Y: _____ m X2: _____ m Y2: _____ m
 Depth: _____ m Height: _____ m
 Influences: Façade A/ Façade B/ Façade C/ Façade D
 Effective from: _____ to: _____
- 20 rectangle/ circle
 X1/ X: _____ m Y1/Y: _____ m X2: _____ m Y2: _____ m
 Depth: _____ m Height: _____ m
 Influences: Façade A/ Façade B/ Façade C/ Façade D
 Effective from: _____ to: _____

Programming of façade _____

- Grid system
 - 1 floor with 50 windows/
 - 10 floors with 5 windows/
 - Distance of left window: _____ cm
 - Width of window: _____ cm
 - Horizontal distance: _____ cm
 - 2 floors with 25 windows each/
 - 50 floors with 1 window each
 - Distance of bottom window: _____ cm
 - Height of window: _____ cm
 - Vertical distance: _____ cm
- User-defined

No.	Distance of left window cm	Width cm	Distance from floor cm
1			
2			
3			
4			
5			
6			
7			
8			
9			
10			
11			
12			
13			
14			
15			
16			
17			
18			
19			
20			
21			
22			
23			
24			
25			

No.	Distance of left window cm	Width cm	Distance from floor cm
26			
27			
28			
29			
30			
31			
32			
33			
34			
35			
36			
37			
38			
39			
40			
41			
42			
43			
44			
45			
46			
47			
48			
49			
50			

5.3 Ordering information

Shutter control module

Designation	Ordering data	Order number	bbn 40 16779 EAN	Price group	Unit price €	Unit weight [kg]	Unit pack [no.]
	Short code						
Shutter control module, MDRC	JSB/S 1.1	GH Q631 0084 R0111	57993 3	26		0.1	1

Shutter actuators

Designation	Ordering data	Order number	bbn 40 16779 EAN	Price group	Unit price €	Unit weight [kg]	Unit pack [no.]
	Short code						
Shutter actuator, 2-fold, 230 V AC, MDRC	JA/S 2.230.1	GH Q631 0071 R0111	57552 2	26		0.25	1
Shutter actuator, 4-fold, 230 V AC, MDRC	JA/S 4.230.1	GH Q631 0072 R0111	57555 3	26		0.25	1
Shutter actuator, 8-fold, 230 V AC, MDRC	JA/S 8.230.1	GH Q631 0063 R0111	57560 7	26		0.5	1
Shutter actuator with manual operation, 4-fold, 230 V AC, MDRC	JA/S 4.230.1M	GH Q631 0064 R0111	57556 0	26		0.26	1
Shutter actuator with manual operation, 8-fold, 230 V AC, MDRC	JA/S 8.230.1M	GH Q631 0078 R0111	57562 1	26		0.52	1
Shutter actuator, 4-fold, 24 V DC, MDRC	JA/S 4.24.1	GH Q631 0073 R0111	57558 4	26		0.25	1

Light and weather sensors

Designation	Ordering data	Order number	bbn 40 16779 EAN	Price group	Unit price €	Unit weight [kg]	Unit pack [no.]
	Short code						
Brightness sensor, 3-channel, MDRC	HS/S 3.1	GH Q605 0063 R0111	50098 2	26		0.18	1
Light value switch, 3-channel, MDRC	LW/S 3.1	GH Q631 0010 R0001	13950 2	26		0.29	1
Weather station, 4-fold, MDRC	WS/S 4.1	2CDG 110 032 R0011	58771 6	26		0.2	1
Weather control unit, MDRC	WZ/S 1.1	2CDG 110 034 R0011	58612 2	26		0.2	1
Weather sensor	WES/A 1.1	2CDG 120 003 R0011	58611 5	26		0.2	1

You can find room controllers, switch sensors and other EIB products in the current ABB i-bus® EIB price list.

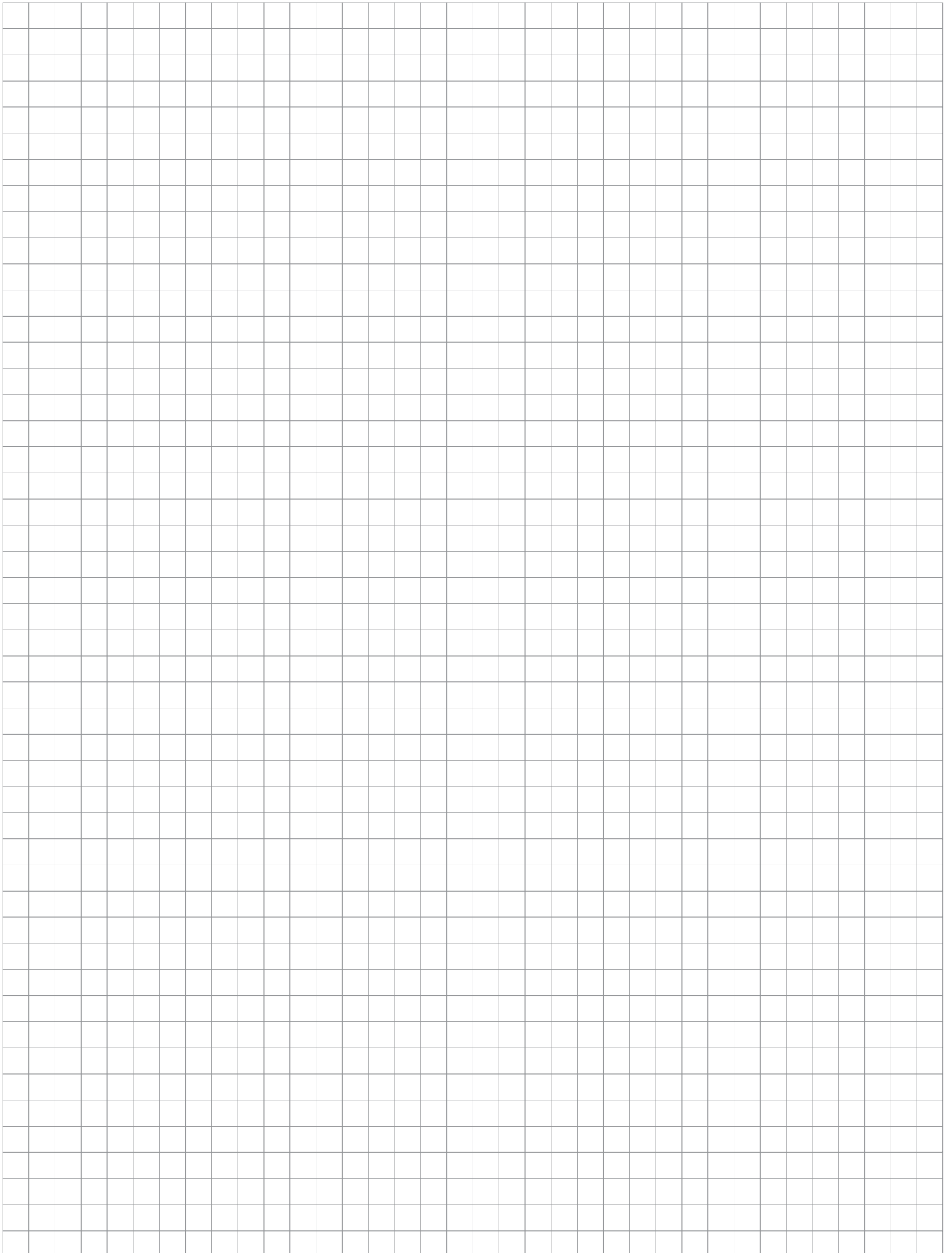

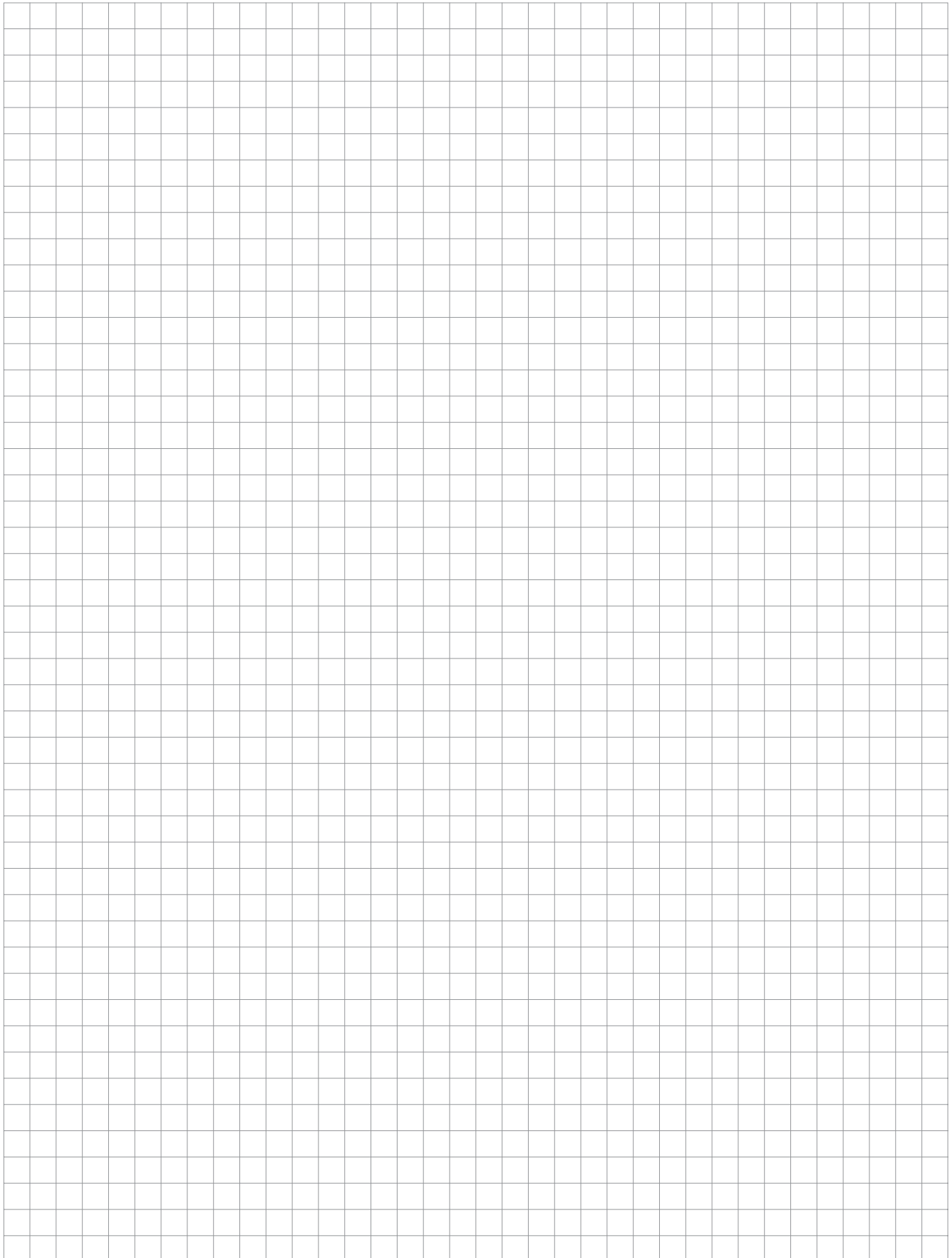



The information in this leaflet is subject to change without further notice.

Pub No.: 2CDC 506 030 D0201

Your EIB-Partner