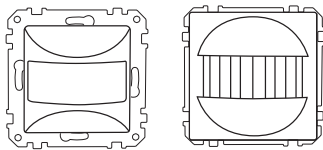
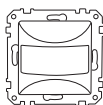
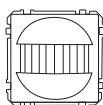

**KNX ARGUS 180, flush-mounted**

## Operating instructions

**System M****KNX ARGUS 180, flush-mounted**  
Art. no. MTN6316.., MTN6326..**Artec, Antik, Tracent****KNX ARGUS 180, flush-mounted**  
Art. no. MTN6318..**For your safety****DANGER****Risk of fatal injury from electrical current.**

All work carried out on the unit may only be performed by skilled electricians. Observe the regulations valid in the country of use, as well as the valid KNX guidelines.

**ARGUS introduction**

The ARGUS 180 flush-mounted (referred to below as **ARGUS**) is a flush-mounted KNX movement detector for indoor installation. It detects moving heat sources, e.g. people, within a radius of 180° and up to a distance of approx. 8 m. The ARGUS is designed for installation at a height of 1.1 m.



The specified ranges refer to average conditions for the recommended mounting height and are therefore guide values. The range and sensitivity can vary greatly when the temperature fluctuates.

When a movement is detected, a data telegram defined by the programming is transmitted. The ambient brightness from which the ARGUS will detect movements can be set with the rotary switch for detection brightness. Dazu verfügt der ARGUS über einen Lichtfühler, dessen Helligkeitsschwelle von 10 bis 1000 Lux eingestellt werden kann (in der ETS von 10 bis 2000 Lux). The range and the overshoot time can be set at two further rotary switches.

The ARGUS has an integrated bus coupler and its power is supplied via KNX.

**i** Movement/presence detectors are not suitable for use as components of an alarm system.

**i** Movement/presence detectors can trigger false alarms if the installation site has been chosen unfavourably.

Movement/presence detectors switch on as soon as they detect a moving heat source. This can be a person, but also animals, trees, cars or differences in temperature in windows. In order to avoid false alarms, the chosen installation site should be such that undesired heat sources cannot be detected (see section „Selecting the installation site“).

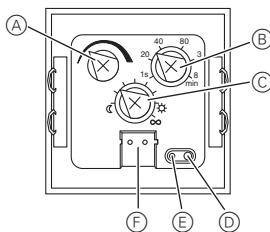
**Connections, displays and operating elements**

- (A) Setting the range
- (B) Setting the overshoot time
- (C) Setting detection brightness
- (D) Programming button
- (E) Programming LED
- (F) Bus connection

**Selecting the installation site**

- Only mount the ARGUS in positions which allow the required area to be monitored optimally.

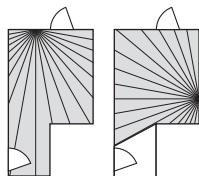

- Observe the area of detection: Install the ARGUS on the wall at a height of approx. 1 - 1.5 m above the floor.
- Install the ARGUS laterally with respect to the direction of movement so that the beam paths are intersected as vertically as possible.

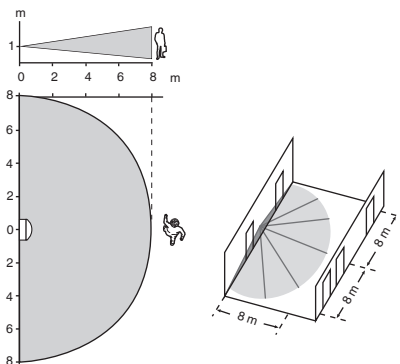

- In order to ensure continuous monitoring, e.g. of a long hall, the areas of detection of the individual movement detectors have to intersect.

- Movement detectors can detect all objects that radiate heat. You should select an installation site that will not result in undesired heat sources being detected, such as:

- switched-on lights in the area of detection
- open fires (such as in fireplaces)
- moving trees, shrubbery, etc. whose temperature differs from that of their surroundings.
- windows where the influence of alternating sunlight and clouds could cause rapid changes in temperature.
- larger heat sources (e.g. cars), that are detected through windows.
- sunlit rooms with reflecting objects (e.g. the floor), which can be the cause of rapid changes in temperature.
- windowpanes heated up by sunlight
- insects moving across the lens.
- dogs, cats, etc.

- To prevent faulty operation, the ARGUS should be installed in a wind-resistant switch box. With switch boxes and pipe cabling systems, a draught of air at the back of the equipment can trigger the ARGUS.
- Avoid direct sunlight. This can destroy the sensor in extreme cases.

**ARGUS installation**

A frame is required for installation.

- ① Connect the bus wires to the bus connecting terminal.
- ② Fit the retaining ring onto the installation box.

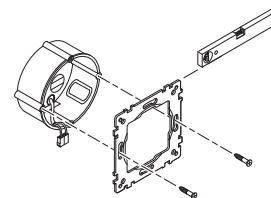

- ③ Insert the ARGUS into the frame.

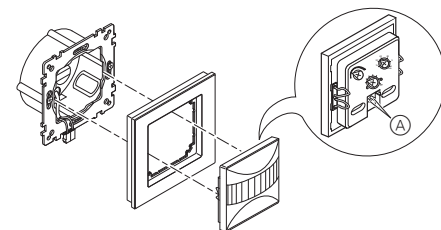

- ④ Plug the bus terminal onto bus connection A of the ARGUS.
- ⑤ Insert the ARGUS with the frame into the retaining ring and click into place.

**Putting ARGUS into operation**

- ① Press the programming button.

The programming LED lights up.

- ② Load the physical address and application into the device from the ETS.

The programming LED goes out.

The application has been loaded successfully, the device is ready for operation.

## Setting ARGUS

You can set the range, detection brightness and overshoot time on the rear of the ARGUS. These settings can also be made in the ETS.

### Setting the range

Here you can infinitely set the distance up to which ARGUS detects movements (up to max. 8 m).

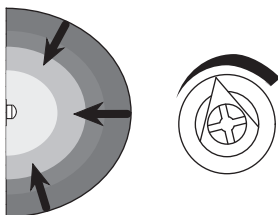

### Setting the detection brightness

Here you can infinitely set the ambient brightness level at which the ARGUS detects movements and triggers a switching procedure.

- Moon symbol (left stop) The ARGUS will only detect movements during the hours of darkness (approx. 10 lux).
- Sun symbol: The ARGUS detects movements up to approx. 1000 lux.
- Infinity symbol (right-hand stop): The ARGUS detects movements regardless of the ambient brightness.

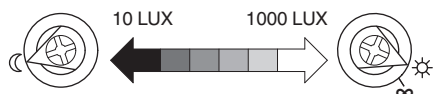

### Setting the overshoot time

With the overshoot time you specify how long the connected load will remain switched on after the last movement has been detected. Depending on the ETS application, the overshoot time is either set in the ETS program (any time between 1 second and 255 seconds) or directly on the ARGUS (six steps from approx. 1 second to approx. 8 minutes).



Once the load has been switched on, the set brightness threshold is ignored. Depending on the settings in ETS, each registered movement can reset the overshoot time from the beginning. If the movement detector no longer switches off, it may be because it is continually detecting new movement and thus extending the overshoot time.

## Technical data

Nominal voltage:	DC 24 V (+6 V / -4 V)
KNX connection:	Bus connecting terminal
Angle of detection:	180°
Number of levels:	1
Number of zones:	14
Recommended mounting height:	1.1 m
Range:	up to approx. 8 m; infinite setting (rotary switch or ETS)
Detection brightness:	Infinite setting from approx. 10 lux to approx. 1000 lux (rotary switch) or from 10 lux to 2000 lux (ETS)
Overshoot time:	Adjustable in 6 steps from approx. 1 s to approx. 8 min (rotary switch) or adjustable from 1 s to 255 hours (ETS)
Display elements:	1 red programming LED
Operating elements:	1 programming button, rotary switch for detection brightness, range, and overshoot time
Ambient temperature	
Operation:	-5 °C to +45 °C
Storage:	-25 °C to +55 °C
Transport:	-25 °C to +70 °C
EC guidelines:	Low-Voltage guideline 73/23/EEC, EMC guideline 89/336/EEC
Initialisation:	Due to the limitation of the telegram rate, a telegram cannot be generated until 20 seconds after initialisation at the earliest.
Type of protection:	IP 20

## Schneider Electric Industries SAS

If you have technical questions, please contact the Customer Care Center in your country.

[www.schneider-electric.com](http://www.schneider-electric.com)

This product must be installed, connected and used in compliance with prevailing standards and/or installation regulations. As standards, specifications and designs develop from time to time, always ask for confirmation of the information given in this publication.