

# ABB i-bus<sup>®</sup> EIB / KNX Shutter Actuator with Manual Operation, 4-fold, SMI, MDRC JA/S 4.SMI.1M

Intelligent Installation Systems



This manual describes the function of the SMI Shutter Actuator JA/S 4.SMI.1M with the application program "Shutter SMI, 4fM/1.1".  
Subject to changes and errors excepted.

**Exclusion of liability:**

Despite checking that the contents of this document match the hardware and software, deviations cannot be completely excluded. We therefore cannot accept any liability for this. Any necessary corrections will be inserted in new versions of the manual.

Please inform us of any suggested improvements.

<b>Contents</b>	<b>Page</b>
<b>1 General</b>	<b>3</b>
1.1 Product and functional overview JA/S 4.SMI.1M.....	4
<b>2 Device technology</b>	<b>5</b>
2.1 Technical data.....	5
2.2 Circuit diagram.....	6
2.3 Dimension drawing .....	7
2.4 Assembly and installation .....	7
<b>3 Commissioning</b>	<b>9</b>
3.1 Application program.....	9
3.2 Parameter windows .....	10
3.2.1 Parameter window "General" .....	10
3.2.2 Parameter window "Manual" .....	14
3.2.3 Parameter window "EIB/KNX" .....	17
3.2.4 Parameter window "Weather" .....	21
3.2.5 Parameter window "SMI Drives" .....	23
3.2.6 Parameter window "Output A-D" .....	24
3.2.7 Parameter window "Safety" .....	28
3.2.8 Parameter window "Status" .....	31
3.2.9 Parameter window "Position" .....	35
3.2.10 Parameter window "Position 1-4" .....	37
3.2.11 Parameter window "Auto 1" .....	39
3.2.12 Parameter window "Auto 2" .....	44
3.2.13 Parameter window "Output A-D scene" .....	46
3.2.14 Parameter window "A-D scene" .....	47
3.3 Communication objects .....	49
3.3.1 Communication objects "Output A-D" .....	49
3.3.2 Communication objects "General" .....	58
<b>4 Planning and application</b>	<b>61</b>
4.1 Standard Motor Interface (SMI) .....	61
4.1.1 Introduction.....	61
4.1.2 Connection .....	62
4.1.3 Commissioning.....	62
4.1.4 SMI technical data.....	63
4.2 Manual operation .....	64
4.2.1 Manual operating states.....	64
4.2.2 UP/DOWN buttons .....	65
4.2.3 LED display .....	66
4.3 Move to position.....	68
4.3.1 Move to position 0% ... 100%.....	68
4.3.2 Move to preset position .....	68
4.3.3 Set preset position .....	69
4.4 Automatic control .....	70
4.4.1 Automatic sun protection.....	70
4.4.2 Automatic heating/cooling .....	75

<b>5</b>	<b>Appendix</b>	<b>78</b>
5.1	Status byte – code table .....	78
5.2	Diagnostic byte code table .....	79
5.3	8-bit scene code table .....	80
5.4	List of drawings .....	81
5.5	List of tables .....	81
5.6	Ordering information .....	82

## 1 General

### Shading

Fitting buildings with shutters and blinds offers numerous benefits such as:

- preventing glare at workstations,
- protecting furniture and carpets from fading,
- regulating the room temperature,
- providing protection from people looking in from the outside,
- giving protection against intruders.

Apart from shutters and blinds, there are numerous other types of hangings available: awnings, roller blinds, curtains, vertical blinds etc. The control of shutters/blinds via motors not only saves the user the task of raising and lowering the blinds by hand but also enables the implementation of fully automatic control. This type of control takes into consideration the time of day, the strength of the sunlight, the temperature conditions, the wind force etc. and positions the shutter/blind in accordance with these factors. The user can of course also adjust this position manually to match his requirements more precisely.

### Control

ABB STOTZ-KONTAKT offers a broad product spectrum of Shutter Actuators for controlling motors for numerous types of shutters/blinds via the EIB/KNX with conventional relay technology as well as via the digital interface SMI (Standard Motor Interface). The shutter control module for positioning the louvres of blinds in accordance with the position of the sun rounds off the range.

The digital SMI interface between actuator and drive is supported by many manufacturers and has become established as the de facto standard for digital shutter control. SMI certified products from different manufacturers are compatible and can be operated simultaneously in a system.

The shutter control with SMI enables even more exact positioning of the shutter as well as evaluation and display of status messages from the drive via the EIB/KNX.

**1.1 Product and functional  
overview  
JA/S 4.SMI.1M**

The Shutter Actuator JA/S 4.SMI.1M from ABB STOTZ-KONTAKT features 4 independent outputs for control of SMI shutters or roller blind drives. In total up to 4 SMI drives can be operated in parallel on an output of the Shutter Actuator. The following functions are available with the application program "Shutter SMI, 4fM/1.1":

- Movement UP/DOWN, stop/louvre adjustment
- Move into position (up to 4 preset positions)
- Set position (modification of the preset position via the EIB/KNX)
- Move to position 0% ... 100%
- Scenes
- Automatic sun protection
- Automatic heating/cooling
- Monitoring of wind, rain and frost alarms (cyclical)
- Block and forced operation
- Status display: current position/louvre position
- Status display: current operating mode
- Status display: current state of the SMI drive
- Modification of parameter settings via the EIB/KNX

## 2 Device technology



Fig. 1: JA/S 4.SMI.1M

The Shutter Actuator JA/S 4.SMI.1M controls four independent groups, each with up to 4 SMI shutter or roller blind drives via the EIB/KNX. The operating buttons on the device can be used to manually raise and lower the shutter/blind as well as to stop it and adjust it in stages. The operating state, information

concerning the respective channels as well as the current direction of motion or position of the shutter/blind are displayed via LEDs. The Shutter Actuator is a rail-mounted device for insertion in the distribution board. The connection to the ABB i-bus® EIB/KNX is established via a terminal.

### 2.1 Technical data

<b>Power supply</b>	Operating voltage	230 V AC +10/-15%, 45 ... 65 Hz
	Bus voltage	21 ...30 V DC via EIB / KNX
	Current consumption EIB / KNX	< 12 mA
	Power consumption EIB / KNX	Max. 250 mW
	Power consumption 230 V AC	Max. 2 W
<b>Outputs</b>	Leakage loss	Max. 1.8 W
	4 independent SMI outputs for up to 4 SMI drives each	
	SMI control voltage	18 V DC
<b>Operating and display elements</b>	SMI cable lengths	Max. 350 m
	Red LED and button	For assignment of the physical address
	Manual operation	2 buttons per output for up and down (long operation) or stop/louvre adjustment (short operation)
	Display direction of motion / end positions / status	2 LEDs per output for up / down, top / bottom, SMI communication, alarm
	Mode	1 button for switchover between manual operation and operation via EIB/KNX
<b>Connections</b>	Operating mode display	1 LED for indication of the operating mode (manual operation / EIB / KNX)
	/ KNX	Bus connection terminal (black/red)
	SMI	2 screw terminals per output (I+; I-) Conductor cross-section: stranded: 0.2 ... 2.5 mm <sup>2</sup> single-core: 0.2 ... 4 mm <sup>2</sup>
<b>Enclosure</b>	230 V AC power supply	2 screw terminals for L 2 screw terminals for N Conductor cross-section: stranded: 0.2 ... 2.5 mm <sup>2</sup> single-core: 0.2 ... 4 mm <sup>2</sup>
	IP 20, EN 60 529	
	<b>Ambient temperature range</b>	Operation
	Storage	- 25° C ... + 55° C
	Transport	- 25° C ... + 70° C
<b>Design</b>	Modular installation device, ProM	
<b>Housing, colour</b>	Plastic housing, grey	
<b>Installation</b>	On 35 mm mounting rail	to DIN EN 50 022
<b>Dimensions</b>	90 x 72 x 64.5 mm (H x W x D)	
<b>Mounting depth / width</b>	68 mm / 4 modules at 18 mm	

<b>Weight</b>	Approx. 0.25 kg
<b>Mounting position</b>	As required
<b>Approvals</b>	EIB / KNX; SMI
<b>CE mark</b>	In accordance with the EMC guideline and low voltage guideline

Table 1: Technical data

Application program	Number of communication objects	Max. number of group addresses	Max. number of associations
Shutter SMI, 4fM/1.1	134	250	250

Table 2: Application program

Note: The programming requires EIB/KNX Software Tool ETS2 V1.1.3 or higher.  
 If ETS3 is used, a “.VD3” type file must be imported. The application program is available in ETS2 / ETS3 under ABB/shutter/switch.

## 2.2 Circuit diagram

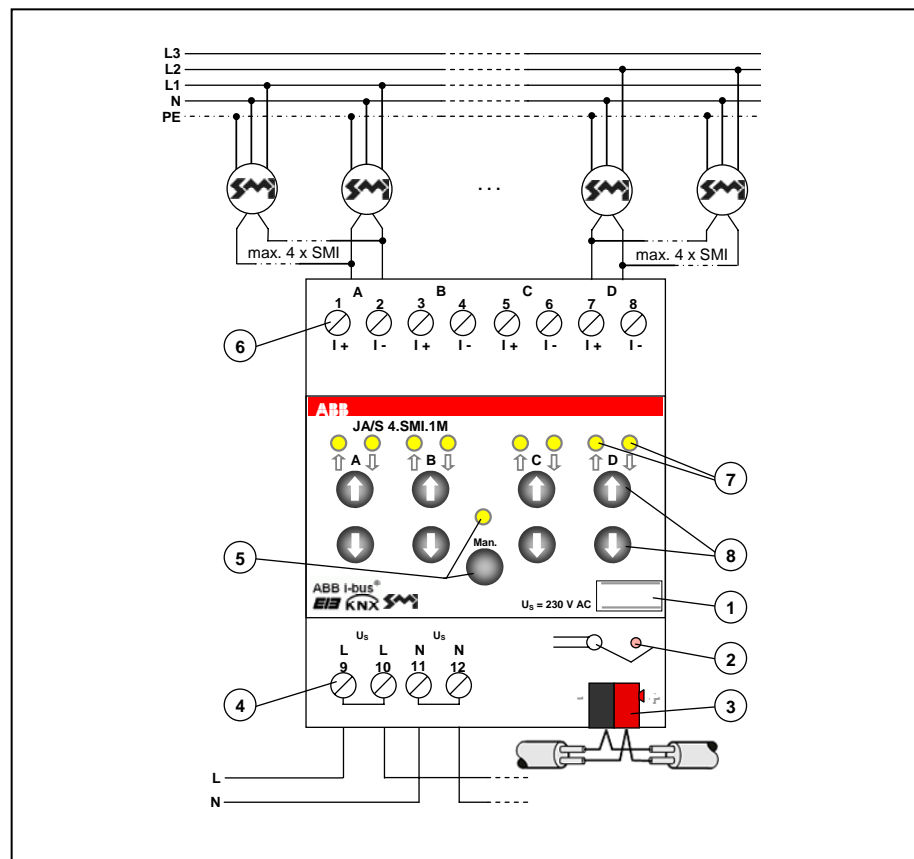

Fig. 2: Wiring drawing JA/S 4.SMI.1M

- |                           |   |
|---------------------------|---|
| 1 Label carrier           | 6 SMI connection terminal (I+; I-)            |
| 2 Programming LED/button  | 7 LED UP / DOWN / Position                    |
| 3 Bus connection terminal | 8 Buttons UP / DOWN / Stop/ louvre adjustment |
| 4 230 V AC power supply   |   |
| 5 LED and "Man." button   |   |



### 2.3 Dimension drawing

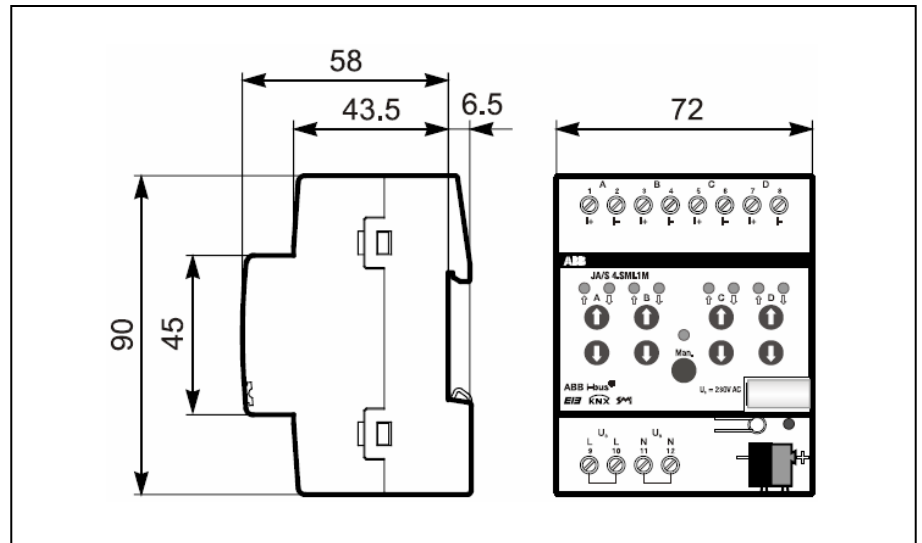

Fig. 3: Dimension drawing JA/S 4.SMI.1M

### 2.4 Assembly and installation

The programming is carried out with ETS from version ETS2 V1.2a onwards.

The Shutter Actuator is supplied with a pre-installed application program. Hence, only group addresses and parameters must be loaded during commissioning. If necessary, the entire user program can be loaded. The device must be unloaded beforehand. Manual operation does not function in the unloaded state.

In the preset state (on delivery), manual operation functions in the “Blinds” mode. With the connection of blinds in the “Blinds” operating mode, it is possible that short jerky movements will result if a brief up/down command (step) is issued via the manual control. The “Blinds” operating mode can be set in the application program and downloaded to the Shutter Actuator.



Before the Shutter Actuator is installed, the upper and lower end positions of the shutter motor must be taught in. The details supplied by the motor manufacturer must be observed. The end position values are stored in the shutter motor.

Connection of 230 V to the SMI control lines I+ and I- can lead to destruction of the device and is not permitted!

The connection of conventional push buttons to the SMI control is not allowed as soon as SMI drives are controlled via the telegram mode of the JA/S 4.SMI.1M.

The manual control keys may not be operated with pointed or sharp-edged objects (e.g. screwdriver, pen, ...) which can damage the keypad.

The LEDs are used exclusively as a status display of the shutter/blind and of the operating state. They are not intended for control of the shutter/blind and may not be pressed/actuated.

Note: The programming LED is supplied via the power supply of the JA/S 4.SMI.1M and via the bus. It lights up after pressing the programming button even without a connection to the EIB/KNX. The LED can therefore only be used to verify the bus connection, if the bus voltage is available and the 230 V supply has been disconnected.

Visible communication objects, which are not required for the function, do not need to be linked to a group address.

Accessibility to the device for the purpose of operation, testing, visual inspection, maintenance and repair must be provided (according to DIN VDE 0100-520).

### 3 Commissioning

#### 3.1 Application program



**Before the Shutter Actuator is installed, the upper and lower end positions of the shutter motor must be taught in. The details supplied by the motor manufacturer must be observed. The end position values are stored in the shutter motor.**

The Shutter Actuator with manual operation, 4-fold, SMI, MDRC with the application program “Shutter SMI, 4fM/1.1” is downloaded via the ETS program from version ETS2 V1.2a or higher.

In order to guarantee simple programming, the application program is structured dynamically, i.e. in the basic setting only very few important communication objects and parameters are visible. The full functionality of the application program becomes visible via the activation of the respective parameters.

The parameter settings can be undertaken for each output separately and are the same for all outputs. Thus, the programming effort can be considerably reduced when setting the parameters. In both cases the communication objects are available separately for each object.

The Shutter Actuator can either be operated in individual mode (one SMI drive per output) or in parallel mode with multiple addressing (up to 4 SMI drives as a group per output). Accordingly, no SMI addressing is necessary during commissioning. The JA/S 4.SMI.1M cyclically checks the bus for (new) drives and can detect and resolve them in the event of an address conflict.

With the exchange and commissioning of an SMI drive, no SMI addressing must be undertaken. Any SMI drives from various manufacturers can be combined with one another.

## 3.2 Parameter windows

In the following sections, the individual parameter windows with their respective parameters are described in exact detail. Parameter values which are written in *italics* are preset settings.

### 3.2.1 Parameter window “General”

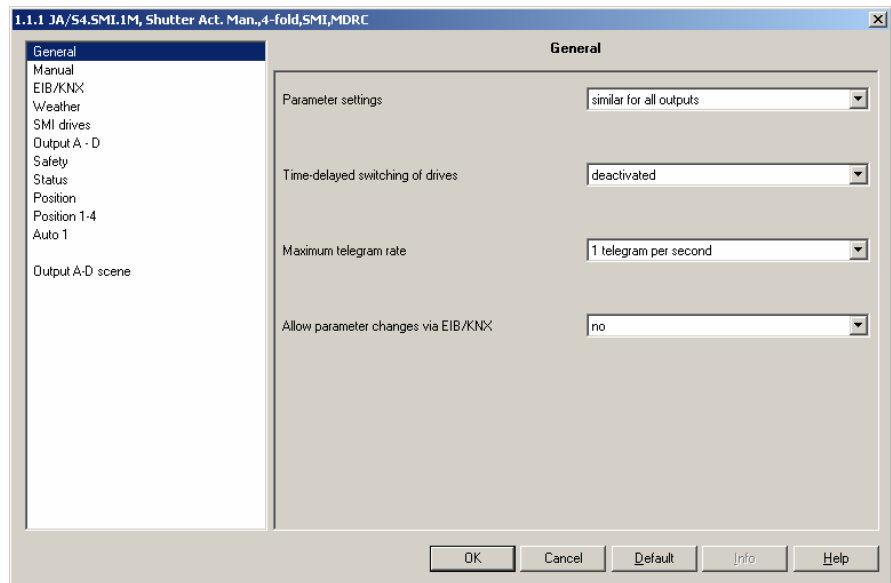

Fig. 4: “General” parameter window

#### Parameter settings

Options:

- *similar for all outputs*
- individual for every output

In the Shutter Actuator an individual setting can be undertaken separately for every output. Particularly in large EIB/KNX systems, it is generally the case that all outputs are assigned the same parameters. In this case all settings only need to be made once in the Shutter Actuator. These settings apply equally for all outputs.

*similar for all outputs:* The parameter window “Output A-D” appears as well as the corresponding parameter windows once in each case.

*individual for every output:* The parameter windows “Output A”, “Output B”, “Output C” and “Output D” as well as the corresponding parameter windows appear four times.

**Time-delayed switching of drives**

Options:           - *deactivated*  
                      - *activated*

In large EIB/KNX systems with several drives, a larger start-up current is required if all the drives start simultaneously via a central command. Movement commands can be delayed in order to limit these start-up currents in such cases.

For example, all the drives of a particular floor can be compiled as a group. Thus, all drives on the ground floor can be implemented using a central movement command without time delay. All drives on the 1st floor can be implemented with a time delay of 2 seconds, etc.

The time delay when undertaking a movement applies for the following communication objects and situations (also valid for active Automatic Control):

- "Move to pos. for sun 0..255", "Adjust louvres for sun 0..255"
- "Block", "Forced operation"
- "Wind alarm", "Rain alarm", "Frost alarm"
- "Move to position 0..255"
- "Move louvre 0..255"
- Programming/reset
- Bus voltage failure
- Bus voltage recovery
- "Reaction on auxiliary voltage recovery", "SMI Reset"
- SMI recovery
- Reset of forced operation

The time delay when undertaking a movement is not considered for the following communication objects:

- "Move blinds Up-Down", "Blinds Up-Down limited"
- "Move shutter Up-Down", "Shutter Up-Down limited"
- "Louvre adj./ Stop Up-Down", "STOP"
- "Move to position 1/2", "Move to position 3/4"

It is thus ensured that the direct operation function, e.g. via a push button, is not time delayed.

*activated*: The "Time Delay" parameter appears.

**Time delay [s]**

Options:           1...15 (1)

The setting for the time delay is made in seconds. The set time delay applies for all channels or connected drives of the actuator.



The parameterised time delay is also active for automatic control, weather alarms and forced operations. Therefore, the time delay should only be used in large systems if a mains voltage failure is expected should all the drives start up simultaneously.

**Maximum telegram rate**

Options: 1 / 2 / 3 / 5 / 10 / 20 telegrams per second

The telegram rate can be limited with this parameter in order to limit the number of status telegrams.

With central commands or after a bus voltage recovery, it is possible that the Shutter Actuator sends several status telegrams via the EIB/KNX. If several Shutter Actuators operate in parallel in the system or are operated on the same line, it is possible that a flood of telegrams will result. Therefore the maximum telegram rate in large EIB/KNX installations should be kept as low as possible.

**Allow parameter changes via EIB/KNX**

Options: - yes  
- no

With this function, defined parameter settings can be changed with a telegram for certain parameter settings without having to make the changes individually on every Shutter Actuator in the parameter window and then download them. In this way, various settings can be tested during commissioning. With a single telegram via a central group, the settings of all Shutter Actuators are undertaken simultaneously.

The following changeable parameters can be found in the parameter windows "Auto 1" and "Auto 2":

- "Time to reactivate automatic control automatically [min.]"
- "Delay for sun = "1" [s]"
- "Delay for sun = "0" [s]"
- "Delay for presence = 1"
- "Delay for presence = 0"

Note: Changes via the EIB/KNX apply for all 4 channels and are saved in the event of bus voltage failure.

For example various delay times can be tested with this function for the reaction to "Sun = 1", or the time for automatic reactivation of the automatic control can be centrally modified.

yes: The parameter changes with "Overwrite parameter changing on download" as well as the communication objects "Time to reactivate automatic control", "Delay for sun = X" and "Delay for presence = X" appear.

Note: If parameter changes have been made via the EIB/KNX during commissioning, the parameter settings in the Shutter Actuator are different from the parameterised settings in the ETS. The final parameter settings should be well documented or even subsequently corrected in the parameter windows, to ensure that the function of the system can be restored at any time.

**Overwrite parameter changing on download**

Options:       - yes  
                  - no

With this parameter, you set if the parameter changes via the EIB/KNX from a download are overwritten by the parameterised settings in the ETS.

### 3.2.2 Parameter window “Manual”

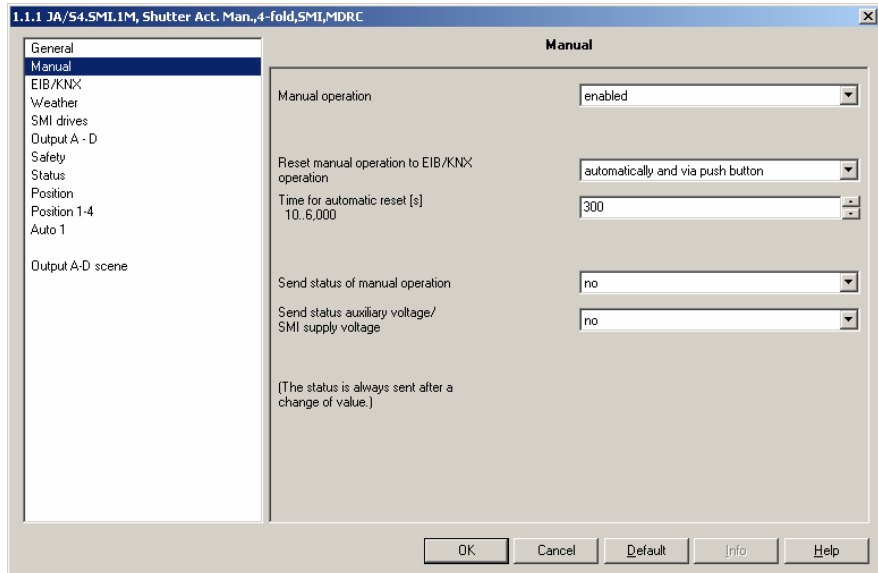

Fig. 5: Parameter window “Manual”

#### Manual operation

- Options:
- *enabled*
  - *disabled*
  - *via object enable/ disable*

The activation of manual operation via the “Man.” button on the front of the device can be activated or deactivated. Furthermore, manual operation can also be enabled or disabled even in ongoing operation via a communication object. For example, it is possible to briefly enable manual operation if maintenance work on site is required. Thereafter, manual mode is again disabled.

Direct objects or commands during manual operation are ignored (e.g. UP/DOWN, Position X,...) and also not implemented after the end of manual operation.

- Note:
- A movement command can be initiated directly and without delay with direct objects or commands:
- Move blinds Up-Down
  - Louvre adj./ Stop Up-Down
  - Blinds Up-Down limited
  - Move to position 0..255
  - Move louvre 0..255
  - Move to position 1/2
  - Move to position 3/4
  - Scene

*Via object enable/ disable:* The communication object “Manual operation enable/disable” is displayed.



**Reset manual operation to EIB/KNX operation**

- Options:
- via push button
  - *automatically and via push button*

If the status of the objects has changed during the manual operation, the actuator will behave with the reset of manual operation as follows:

- If a safety relevant function is active, no reaction
- If automatic control is active, movement to the automatic position is carried out.

*via push button:* The Shutter Actuator remains in manual mode until the "Manual" button is pressed again.

*Automatically and via push button:* The Shutter Actuator remains in manual mode until the "Manual" button is pressed again or the parameterised time has timed out. The parameter "Time for automatic reset" is displayed.

**Time for automatic reset [s]**

- Options: 10..6.000 (300)

For setting the time for automatic reset of manual operation for operation via the EIB/KNX. The automatic reset is performed after the last manual operation and after time-out of the set time.

Note: If a safety function is active during manual operation (weather alarm, forced operation), the blind is moved to the parameterised safety position and the manual operation of the channel concerned is deactivated as long as the safety function is active.

**Send status of manual operation**

- Options:
- yes
  - no

The Shutter Actuator can be switched over (toggled) between manual operation and EIB/KNX operation via the "Manual" button. The status of the current manual mode is sent via the EIB/KNX.

yes: The communication object "Telegr. status manual operation" is displayed.

**Send status auxiliary voltage/ SMI supply voltage**

Options:       - *yes*  
                  - *no*

Used for sending a power supply voltage failure via the EIB/KNX.

*yes*: The communication object "Telegr. status of auxiliary voltage" is displayed.

**Note:**        If the auxiliary voltage (230 V) fails, the SMI supply is also interrupted. The reaction of the auxiliary voltage supply depends on the SMI drive and should be read in the technical documentation of the respective manufacturer. With the return of the auxiliary voltage, the Shutter Actuator reads the value of the communication objects and positions the shutter/blinds accordingly. For example, it activates the automatic function or moves to the wind alarm position. Commands are carried out in accordance with the parameterised time delay.

### 3.2.3 Parameter window “EIB/KNX”

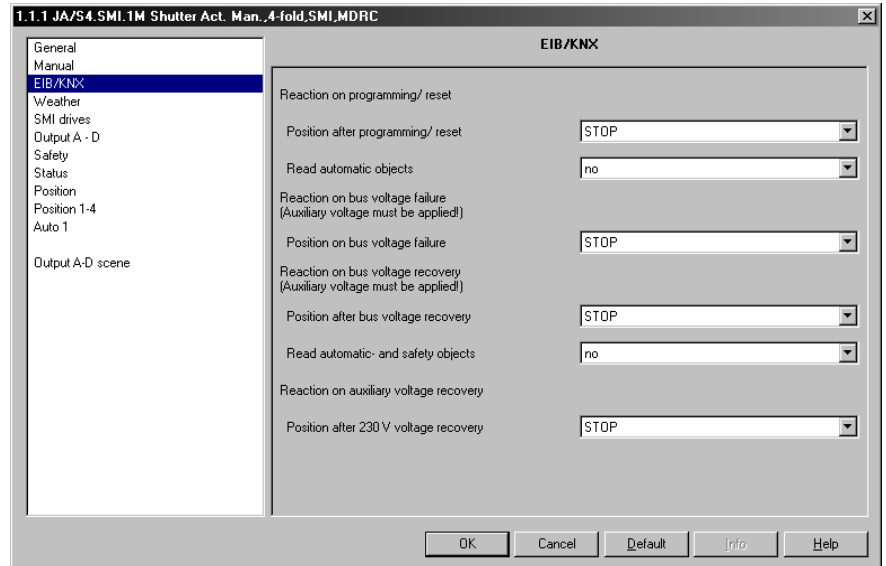

Fig. 6: Parameter window “EIB/KNX”

#### Reaction on programming/ reset

No movement actions are undertaken during programming or during a bus reset. Manual operation is automatically deactivated and cannot be reactivated until the completion of programming or a bus reset. If the shutter/blind is carrying out a movement function at the start of programming or during the bus reset, the movement continues to the target position.

#### Position after programming/ reset

- Options:
- no reaction
  - UP
  - DOWN
  - *STOP*
  - Position 1 to Position 4

With this parameter, the shutter/blind position is set after programming or a reset.

After completion of the programming or the bus reset, the shutter/blind is moved to the parameterised position. The current position of the shutter/blind as well as the status of the drive is queried via SMI and the feedback communication object is updated. The Shutter Actuator is in the mode “Operation via EIB/KNX” and the “Man.” LED is switched off.

*no reaction:* If the shutter/blind is performing a movement, this movement to the target position is carried out. If the shutter/blind is at rest, it will remain unchanged in its position.

*STOP:* If the shutter/blind is performing a movement, this movement stops immediately. If the shutter/blind is at rest, it will remain unchanged in its position.

*Position 1 - Position 4:* If this position is selected, the shutter/blind moves to a preset position after programming/reset. The shutter/blind height and louvre setting of the corresponding position can be set in the parameter windows "Position 1-4" (see also chapter 3.2.10).

#### Read automatic objects

Options:           - yes  
                      - no

With this parameter, you set if the automatic communication objects (no. 10 – 17) read their value via the EIB/KNX.

The automatic objects assume the value "0" after programming and reset. The current value of the automatic communication objects can be requested via the EIB/KNX. If this has occurred, the status of the Shutter Actuator is updated to correspond to the read values, e.g. automatic control is activated.

#### Reaction on bus voltage failure Position on bus voltage failure

Options:           - no reaction  
                      - UP  
                      - DOWN  
                      - STOP  
                      - Position 1 to Position 4

With a bus voltage failure the shutter/blind is moved to the parameterised position (only with applied auxiliary voltage).

*no reaction:* If the shutter/blind is performing a movement, this movement to the target position is carried out. If the shutter/blind is at rest, it will remain unchanged in its position.

*Position 1 - Position 4:* If this position is selected, the shutter/blind moves to a preset position after bus voltage failure. The shutter/blind height and louvre setting of the corresponding position can be set in the parameter windows "Position 1-4" (see also chapter 3.2.10).

#### Reaction on bus voltage recovery Position after bus voltage recovery

Options:           - no reaction  
                      - UP  
                      - DOWN  
                      - STOP  
                      - Position 1 to Position 4

With a bus voltage recovery the shutter/blind is moved to the parameterised position (only with existing 230 V auxiliary voltage). The current position of the shutter/blind as well as the status of the drive is queried via SMI and the feedback communication object is updated. The Shutter Actuator remains in the current operating state "Operation via EIB/KNX" or "Manual operation".

*no reaction:* If the shutter/blind is performing a movement, this movement to the target position is carried out. If the shutter/blind is at rest, it will remain unchanged in its position.

*STOP:* If the shutter/blind is performing a movement, this movement stops immediately. If the shutter/blind is at rest, it will remain unchanged in its position.

*Position 1 - Position 4:* If this position is selected, the shutter/blind moves to a preset position after bus voltage recovery. The shutter/blind height and louvre setting of the corresponding position can be set in the parameter windows "Position 1-4" (see also chapter 3.2.10).

#### **Read automatic- and safety objects**

Options:

- yes - safety, automatic
- yes – safety
- yes – automatic
- no

With this parameter, you set if the automatic communication objects (no. 10 – 17) and safety objects (no. 19-20 and no. 124-128) read their value via the EIB/KNX.

The automatic and safety objects assume the value "0" after programming and reset. The current value of the automatic and safety objects can be requested via the EIB/KNX. If this has occurred, the status of the Shutter Actuator is updated to correspond to the read values, e.g. automatic control is activated.

#### **Reaction on auxiliary voltage recovery Position after 230 V voltage recovery**

After auxiliary voltage recovery, the shutter/blind moves to the parameterised position. The current position of the shutter/blind as well as the status of the drive are queried via the SMI and the feedback communication objects are updated (only if bus voltage available). The Shutter Actuator remains in the current operating state "Operation via EIB/KNX" or "Manual operation".

Options:

- *no reaction*
- UP
- DOWN
- STOP
- Position 1 to Position 4
- according to object value

*no reaction:* The shutter/blind remains unchanged in its current position.

*STOP:* If the shutter/blind is performing a movement, this movement stops immediately. If the shutter/blind is at rest, it will remain unchanged in its position.

*Position 1 - Position 4:* If this position is selected, the shutter/blind moves to a preset position after auxiliary voltage recovery. The shutter/blind height and louvre setting of the corresponding position can be set in the parameter windows "Position 1-4" (see also chapter 3.2.10).

*According to object value:* Incoming EIB/KNX telegrams during a failure of the auxiliary voltage are saved (only if bus voltage available). After auxiliary voltage recovery, the shutter/blind is moved to the position which was last received at the following objects

- "Move to position 1/2/3/4"
- "Move to position 0..255"
- "Move louvre 0..255"

The position after auxiliary voltage recovery is only adopted if

- no weather or safety alarm is active
- manual operation is inactive
- automatic control is inactive

The positions are only adopted after a parameterised delay.

### 3.2.4 Parameter window “Weather”

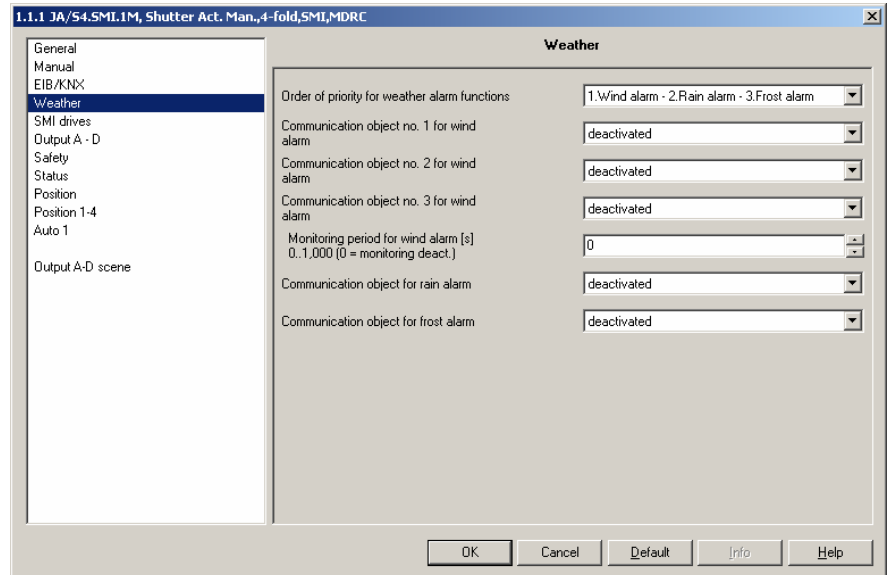

Fig. 7: Parameter window “Weather”

#### Priority sequence of the weather alarms

- Options:
- 1.Wind alarm - 2.Rain alarm - 3.Frost alarm
  - 1.Wind alarm - 2.Frost alarm - 3.Rain alarm
  - 1.Rain alarm - 2.Wind alarm - 3.Frost alarm
  - 1.Rain alarm - 2.Frost alarm - 3.Wind alarm
  - 1.Frost alarm - 2.Wind alarm - 3.Rain alarm
  - 1.Frost alarm - 2.Rain alarm - 3.Wind alarm

If more than one weather alarm occurs simultaneously, then only one weather alarm with the highest priority is carried out. With this parameter, the priority between the weather alarm functions is defined.

#### Communication object no. 1 for wind alarm

#### Communication object no. 2 for wind alarm

#### Communication object no. 3 for wind alarm

#### Communication object for rain alarm

#### Communication object for frost alarm

- Options:
- *deactivated*
  - *activated*

For activation of the weather alarm functions and the corresponding communication objects.

**Monitoring period for wind alarm [s]**  
**Monitoring period for rain alarm [s]**  
**Monitoring period for frost alarm [s]**

Options: (0)...1.000

The weather sensors are cyclically monitored by the Shutter Actuator, i.e. the weather sensors cyclically send their status (telegram value = 0, weather sensor inactive) and the Shutter Actuator expects this signal. If the signal is not received within the monitoring period parameterised for the Shutter Actuator, the Shutter Actuator assumes that the sensor is defective or that the bus cable is interrupted and moves all shutters/blinds to the parameterised alarm position. The operation is inhibited.

If the weather sensor sends the telegram value = 1 (weather sensor active), the shutters/blinds immediately move to the parameterised alarm position.

The parameter "Monitoring period for rain alarm [s]" or "Monitoring period for frost alarm [s]" is displayed, as soon as the parameters "Communication object for rain alarm" or "Communication object for frost alarm" have been set with the option *activated*.

With these parameters, the cyclical monitoring time for wind, rain and frost alarm are set in seconds.

"0": The cyclical monitoring is deactivated



The monitoring period in the Shutter Actuator should be selected to be at least three to four times as long as the cyclical transmission time of the sensor, so that the immediate absence of a signal (e.g. due to a high bus load) does not immediately result in the shutter/blind being moved to the alarm position.



### 3.2.5 Parameter window “SMI Drives”

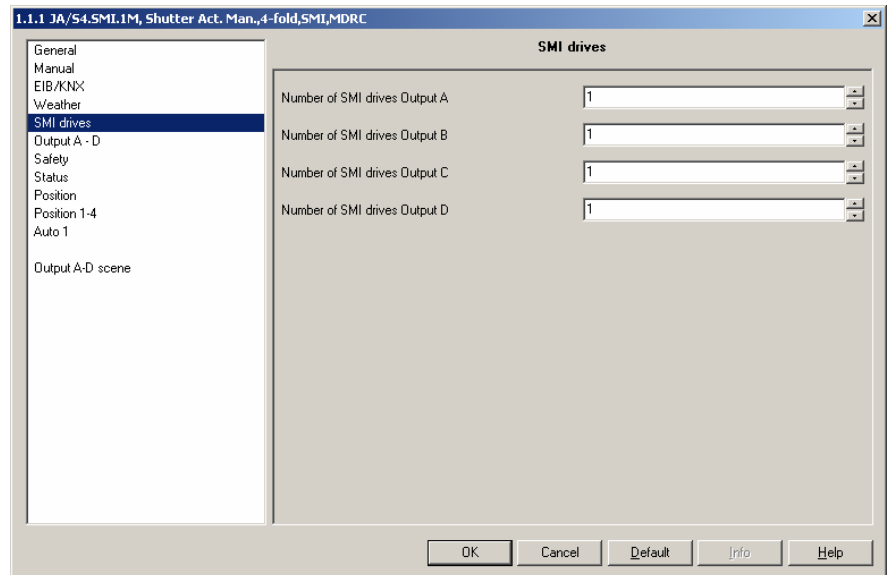

Fig. 8: Parameter window “SMI Drives”

**Number of SMI drives Output A**  
**Number of SMI drives Output B**  
**Number of SMI drives Output C**  
**Number of SMI drives Output D**

Options: 0..4 (1)

With this parameter, the number of drives which are to be connected to each SMI output are parameterised. The output is inactive if “0” is parameterised.

Regular scanning of all drives connected to an SMI output can detect a missing or additional drive and an error telegram is sent to communications object no. 29 via the EIB/KNX.

A maximum of four SMI drives can be connected to an output.

**Note:** If more than a maximum of four drives per SMI output are detected, the actuator will initiate the safety and alarm functions. No commands via the EIB/KNX are carried out. Operation via the manual buttons on the front of the device is still possible.

### 3.2.6 Parameter window “Output A-D”

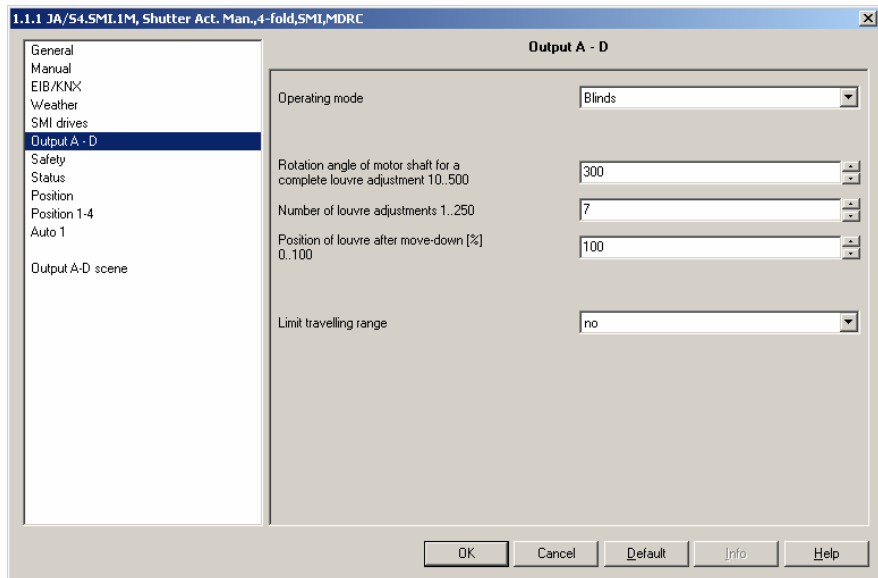

Fig. 9: Parameter window “Output A-D”

#### Operating mode

Options:       - *Blinds*  
                  - *Shutter*

For setting the mode: The “Blinds” mode is particularly suitable for actuation of blinds with the functions Move UP/DOWN and STOP/Louvre adjustment.

The “Shutter” mode is particularly suitable for control of shutters, awnings, roller blinds and other shutters/blinds with the functions ‘Move UP/DOWN’ and ‘STOP’ as well as the control of doors and windows.

The functions in both modes are only slightly different. In the “Blinds” mode, a few additional parameters and communication objects are available.

### Rotation angle of motor shaft for a complete louvre adjustment 10..500

Options: 10..500 (300)

In order to adjust the rotation angle of the motor shaft (= blind shaft) for a complete louvre adjustment. This angle is the basis for the calculation of the number of louvre adjustments (steps), which are necessary to fully open or fully close (see Fig. 10) the blind in steps.

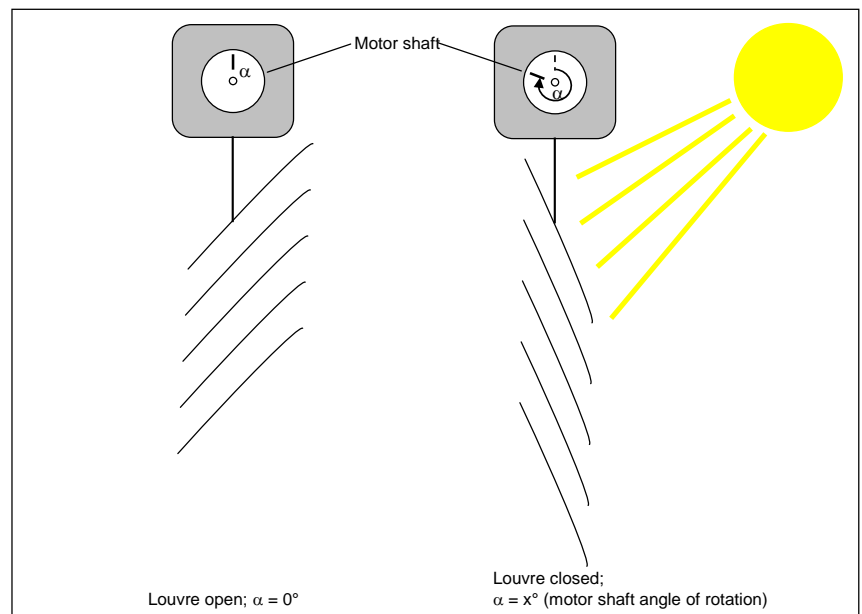

Fig. 10: Rotation angle of the motor shaft

The angle of rotation of the motor shaft for a complete adjustment of the louvre is dependent on the corresponding shutter/blind type and can be queried by the manufacturer or the blind fabricator.

Alternatively the angle of rotation can also be determined during commissioning. Proceed as follows:

- For the maximum angle of rotation a value of 360° is initially assumed in the parameter *Rotation angle of motor shaft for a complete louvre adjustment* (see Fig. 9)
- The number of louvre settings in the parameter of the same name is set to 36. Thus, a resolution of 10° per louvre step results (see Fig. 9).
- The value of the parameter *Position of louvre after move-down [%] 0..100* must be set to be completed at 100% (default factory setting) (see Fig. 9).
- The blind actuator must now be programmed or loaded with these settings.
- After this process the blinds must be moved manually to the “DOWN” end position via manual control on the Shutter Actuator.
- Now the blind is fully opened manually with individual step commands using manual control. The number of step commands required must be counted.

- The maximum angle of rotation of the motor shaft can now be calculated:

$$\text{Angle of rotation} = \text{counted step commands} \times 10^\circ$$

Example: 28 step commands  $\times 10^\circ = 280^\circ$

This value must now be entered in the parameter *Rotation angle of motor shaft for a complete louvre adjustment*.

Now the value of the parameter *Number of louvre adjustments 1..250* can be selected between 1 and 250.

Note: SMI enables the smallest possible angle of rotation per step command of  $2^\circ$  on the motor shaft.

### **Number of louvre adjustments 1..60**

Options: 1..250 (7)

For setting the number of steps to be completed (short push button action), in order to tilt the louvres from fully open to fully closed. First of all the angle of rotation of the motor shaft for a complete louvre adjustment must be determined (see Parameter "Rotation angle of motor shaft for a complete louvre adjustment [°] 10..500").

### **Position of louvre after move-down [%] 0..100**

Options: 0...100% (100)

After a downward movement to the lower end position, the louvres are closed. Thereafter movement to the parameterised louvre position is carried out.

The same louvre position is also set if the lower limit is reached after a limited downward movement.

"0%": louvre open

"...%": intermediate position

"100%": louvre closed

Note: This position is only adopted in conjunction with a movement command in the communication objects "Move blinds Up-Down" and "Blinds Up-Down limited" as well as in conjunction with a manual downward movement. It is not adopted due to a movement based on forced operation!

**Limit travelling range**

Options:        - *yes*  
                  - *no*

For certain applications, the travelling range of the shutter/blind can be limited for the user. For example the opening and closing of the skylights can be limited for a certain group of users to a range between 0 and 20% open, while the building caretaker may operate the complete range of movement.

*yes*: The communication object "Blinds Up-Down limited" as well as the parameter "Upper limit [%] 0..100" and "Lower limit [%] 0..100" are displayed.

*Note*:        The movement range limitation only functions via the "Blinds Up-Down limited" object. The limits of the parameters "Upper limit [%] 0..100" and "Lower limit [%] 0..100" do not apply to all other objects.

**Upper limit [%] 0..100****Lower limit [%] 0..100**

Options:        0...100 (*0*)

This parameter only appears if the "Limit travelling range" parameter is set to "yes".

For setting the upper and lower limit of the movement range.

"0%":    upper limit

"...%":  intermediate position

"100%": lower limit

### 3.2.7 Parameter window “Safety”

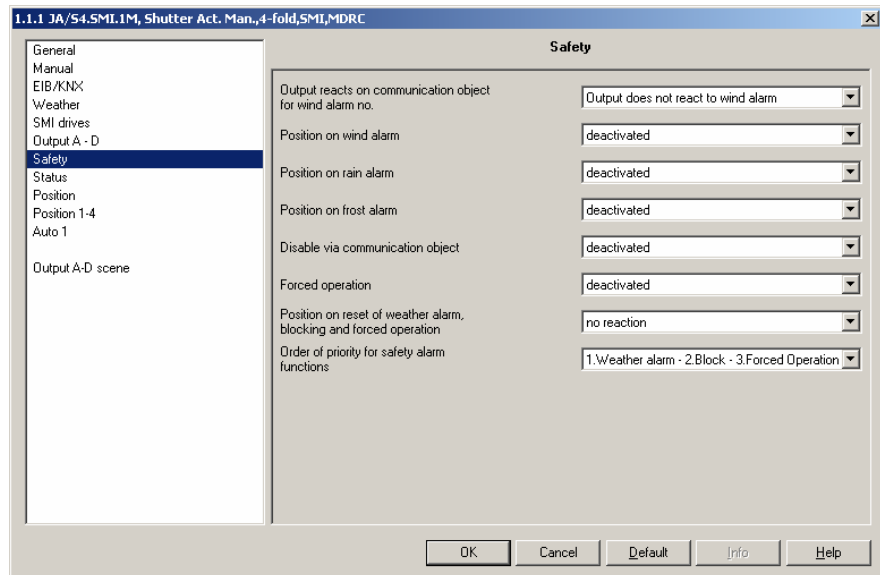

Fig. 11: Parameter window “Safety”

#### Output reacts on communication object for wind alarm no.

Options:           - *Output does not react to wind alarm*  
                      - 1/ 2/ 3/ 1+2/ 1+3/ 2+3/ 1+2+3

This parameter is used to set the wind alarm objects to which the output reacts. The values of the assigned communication objects are linked by a logic OR.

#### Position on wind alarm

#### Position on rain alarm

#### Position on frost alarm

Options:           - activated - no reaction  
                      - activated - up  
                      - activated - down  
                      - activated - stop  
                      - *deactivated*

For protection against wind, rain and frost, the Shutter Actuator can move the shutter/blind to a parameterised position after a weather alarm (wind, rain, frost) is received. The shutter/blind can no longer be operated via other communication objects, or even manually, until the weather alarm has been reset.

*no reaction:* If the shutter/blind is performing a movement, this movement to the target position is carried out. If the shutter/blind is at rest, it will remain unchanged in its position.

*STOP:* If the shutter/blind is performing a movement, this movement stops immediately. If the shutter/blind is at rest, it will remain unchanged in its position.

**Disable via communication object**

Options:           - activated  
                      - *deactivated*

The shutter/blind can be moved to a parameterised position and operation can be disabled with the disable function. For example, using this function, the operation of an internal shutter/blind (internal blind or roller blind) can be disabled if the window is opened.

*activated*: The communication object "Block" as well as the parameters "Position during blocking" and "Position on reset of weather alarm, blocking and forced operation" is displayed.

**Position during blocking**

Options:           - *no reaction*  
                      - UP  
                      - DOWN  
                      - STOP  
                      - Position 1 to Position 4

For adjustment of the shutter/blind position during blocking.

*no reaction*: If the shutter/blind is performing a movement, this movement to the target position is carried out. If the shutter/blind is at rest, it will remain unchanged in its position.

*STOP*: If the shutter/blind is performing a movement, this movement stops immediately. If the shutter/blind is at rest, it will remain unchanged in its position.

**Forced operation (2-bit)**

Options:           - activated  
                      - deactivated

With the forced operation function, the shutter/actuator can be raised or lowered via a 2-bit telegram and the operation can be inhibited. For example, the forced operation function can be used to move blinds upwards if the windows are being cleaned or downwards if the louvres are being cleaned. At the same time the operation of the shutter/blind is blocked to ensure that the cleaning personnel are not endangered by an unexpected movement.

*activated*: The communication object "Forced operation" appears.

**Position on reset of weather alarm, blocking and forced operation**

- Options:
- *no reaction*
  - UP
  - DOWN
  - STOP
  - Position 1 to Position 4
  - according to object value

For setting the shutter/blind position on reset of a weather alarm, lockout or forced operation.



Automatic control has higher priority than parameter options (*UP, DOWN, STOP, Position 1-4, according to objekt value*). That means, an activated automatic control will be interrupted in case of a weather alarm, blocking command or a forced operation. After reset of weather alarm, blocking command or forced operation the automatic control will be reactivated.

*according to object value:* During a safety alarm, the incoming EIB/KNX telegrams on direct communication objects are saved. The status of the Shutter Actuator is updated to correspond to the current values of the communication objects, e.g. automatic control is activated. If no new telegrams have been received in the meantime, then the shutter/blind is moved to the position it held when the safety alarm occurred.

With this parameter setting, incoming telegrams are saved on the following objects:

- Move blinds (shutters) Up-Down
- Blinds (shutters) Up-Down limited
- Move to position 0..255
- Move louvre 0..255
- Move to position 1/2
- Move to position 3/4

**Order of priority for safety alarm functions**

- Options:
- 1. *Weather alarm* - 2. *Block* - 3. *Forced Operation*
  - 1. *Weather alarm* - 2. *Forced Operation* - 3. *Block*
  - 1. *Block* - 2. *Weather alarm* - 3. *Forced operation*
  - 1. *Block* - 2. *Forced Operation* - 3. *Weather alarm*
  - 1. *Forced Operation* - 2. *Block* - 3. *Weather alarm*
  - 1. *Forced Operation* - 2. *Weather alarm* - 3. *Block*

The safety functions weather alarms (wind, rain, frost), blocking and forced operation have priority over all other functions of the Shutter Actuator. If one of these functions is activated, the operation of the shutter/blind is inhibited.

A priority must also be defined for the safety functions among one another in order to correctly control the shutter/blinds, if more than one safety function is activated simultaneously. It is possible for example to determine that the forced operation has priority when cleaning a window over a wind alarm, so that the cleaning personnel are not surprised by an upward movement command due to a wind alarm during cleaning.



### 3.2.8 Parameter window "Status"

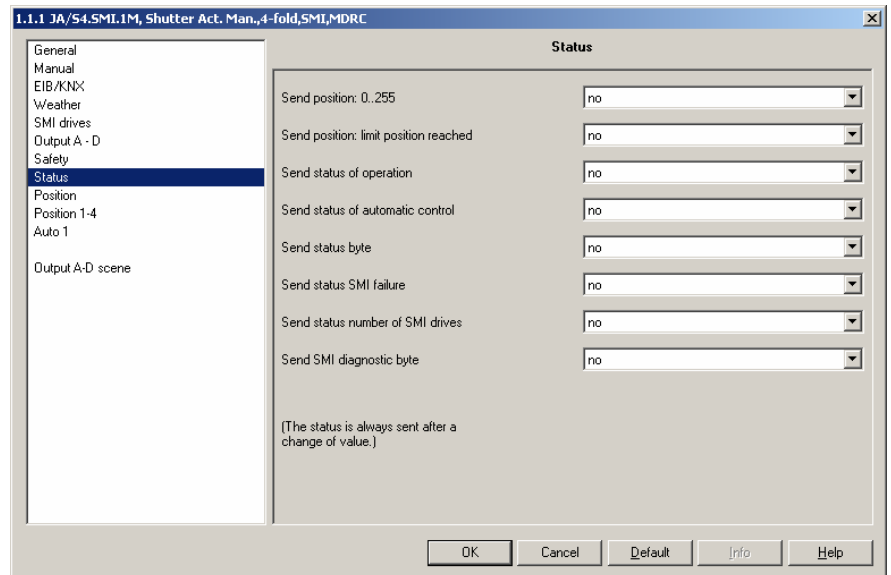

Fig. 12: Parameter window "Status"

#### Send position: 0..255

Options:       - *yes*  
                  - *no*

The Shutter Actuator sends the relative position of the shutter/blinds and the position of the louvres to two separate communication objects each as a 1-byte value (0...255).

The following applies for the position of the shutter/blinds: The value "0" corresponds to the position "upper" (0%). The value "255" corresponds to the position "lower" (100%).

The following applies for the position of the louvres: The value "0" corresponds to the louver position "opened" (0%). The value "255" corresponds to the louver position "closed" (100%).

*yes*: The communication objects "Telegr. status of position 0..255" and "Telegr. status louver 0..255" (only in "Shutter" mode) appear.

**Send position: limit position reached**

Options:       - *yes*  
                  - *no*

The Shutter Actuator sends the information about whether the shutter/blinds are in the upper or lower end position to two separate communication objects (each 1 bit). If the information is sent to both communication objects stating that the respective end position is not reached, the shutter/blinds are in an intermediate position.

This function is particularly suitable for interlocking the outputs via a further logic function, e.g. the awnings may not move if the window is opened and the window may also not be opened by a drive if the awning is extended.

yes: The communication objects "Telegr. status of upper pos." and "Telegr. status of lower pos." are displayed.

**Send status of operation**

Options:       - *yes*  
                  - *no*

During a weather alarm, a disable command or a forced operation, the operation of the shutter/blinds is disabled. Even when manual operation is activated via the "Man." button, the shutter/blinds cannot be operated via the EIB/KNX.

This function is particularly suitable for indicating to the user via an LED that the shutter/blinds cannot be moved to the upper or lower end position and that automatic control cannot be activated.

yes: The communication object "Telegr. status of operation" is displayed.

**Send status of automatic control**

Options:       - *yes*  
                  - *no*

The Shutter Actuator sends information about whether the automatic control is activated or deactivated (1 bit).

This function is particularly suitable for indicating to the user via an LED if the automatic control is activated.

yes: The communication object "Telegr. status of aut. control" is displayed.

**Send status byte**

Options:       - *yes*  
                  - *no*

The drives connected to the Shutter Actuator can be operated via several special functions. For example, the wind alarm can inhibit operation or the automatic control is activated or manual operation is switched on. The status byte provides exact information in which the following function types indicate how an output of the Shutter Actuator is controlled:

- Automatic sun protection
- Automatic heating/cooling
- Wind alarm
- Rain alarm
- Frost alarm
- Forced positioning
- Block
- Manual operation

This function is particularly suitable for analysing the reaction of the Shutter Actuator to an incoming telegram during commissioning or troubleshooting.

yes: The communication object "Telegr. status byte" is displayed.

**Send status SMI failure**

Options:       - *yes*  
                  - *no*

If a drive is defective, no longer connected or is currently being programmed, the Shutter Actuator will not receive an acknowledgement via the SMI when undertaking a movement. In this case it will send an error message via the communication object "Telegr. status SMI failure".

yes: The communication object "Telegr. status SMI failure" is displayed.



If multiple drives are wired in parallel with an output, the failure/absence of a drive cannot be determined, because the other drives still acknowledge a movement. Only when a drive is no longer available on the output will an SMI error be reported.

The communication object "Telegr. status SMI failure" is also sent if the 230 V auxiliary voltage fails.

**Send status number of SMI drives**

Options:       - *yes*  
                  - *no*

If the number of parameterised drives differs from the number of connected drives per channel, the Shutter Actuator sends an error message via the communication object "Telegr. status number of drives".

*yes*: The communication object "Telegr. status number of drives" is displayed.



If more than four drives are connected to a channel, the actuator will only carry out alarm and safety functions. No commands via the EIB/KNX are carried out. Operation of the manual buttons on the front of the device is still possible.

**Send SMI diagnostic byte**

Options:       - *yes*  
                  - *no*

Using this communication object, the Shutter Actuator sends current information concerning the connected SMI drives to the EIB/KNX.

- More than 4 drives detected on SMI
- Less drives detected than configured
- At least one drive cannot be identified via its ID
- Short-circuit on SMI (hardware fault)
- Motor fault
- Motor moves down
- Motor moves up
- No communication

This function is particularly suitable for analysing the reaction of the drive to an incoming telegram during commissioning or troubleshooting.

*yes*: The communication object "Telegr. diagnostic byte" is displayed.

### 3.2.9 Parameter window "Position"

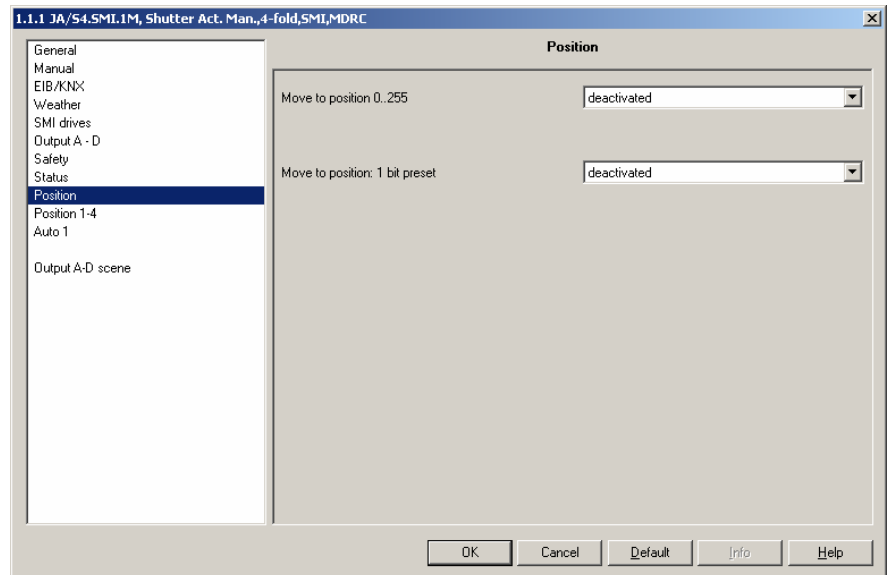

Fig. 13: Parameter window "Position"

#### Move to position: 0..255

Options:           - *deactivated*  
                      - *activated*

The shutter/blind can be moved to any desired position and the louvres can be positioned at any desired angle via two separate communications objects. Both communications objects are 1-byte objects (0..255).

The following applies for the position of the shutter/blinds: The value "0" corresponds to the position "upper" (0%). The value "255" corresponds to the position "lower" (100%).

The following applies for the position of the louvres: The value "0" corresponds to the louvre position "opened" (0%). The value "255" corresponds to the louvre position "closed" (100%).

With these communication objects, an individual position can be sent with every movement command. This is suitable particularly for central commands, if all shutters/blinds on a façade have to be moved to the same position.

*activated*: The communication objects "Move to position 0..255" and "Move louvre 0..255" are displayed.

**Move to position: 1 bit preset**

Options:           - *deactivated*  
                      - *activated*

In the Shutter Actuator up to 4 preset positions can be set for each output. Each of these preset positions can be retrieved via a 1-bit telegram. The shutter/blind is moved to the saved position and assumes the saved louvre setting.

This function is suitable particularly for repeated movement to preferred shutter/blind positions, e.g. by pressing a button or for integration in a scene, which is accessed via a 1-bit telegram.

The saved preset positions can be very easily changed without programming of the Shutter Actuator via the EIB/KNX. The shutter/blinds must simply be brought to the new required target position. The new position is adopted via a 1-bit telegram as a new preset position into the memory of the Shutter Actuator.

Retrieving and saving a preset position can be undertaken with a single button, if for example, a position is accessed with a short push button action and the current position is then saved as the new preset position with a long push button action (see the example in the "Planning and application" chapter 4.3.2).

*activated*: The communication objects "Move to position 1/2", "Move to position 2/4", "Set position 1/2" and "Set position 3/4" are displayed.

### 3.2.10 Parameter window "Position 1-4"

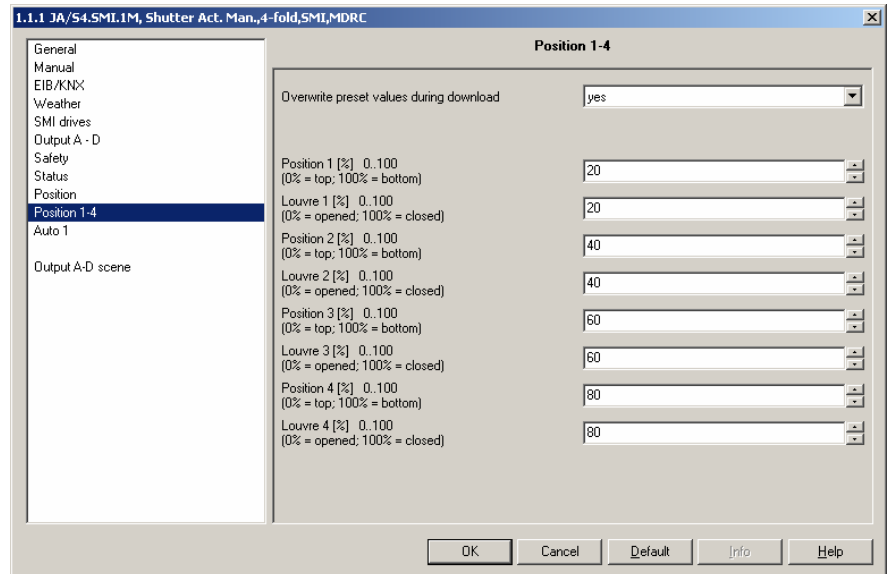

Fig. 14: Parameter window "Position 1-4"

#### Overwrite preset values during download

Options:       - yes  
                  - no

The saved preset positions can be reset via a telegram without the need to program them. The users can thus set the preset positions to suit their specific requirements.

These individual preset positions should also generally remain saved, if the programming of the Shutter Actuator is changed by a download. With this parameter you can set if the saved preset values are overwritten during a download by the parameterised preset values.

yes: The parameters "Position X" and "Louvre X" are displayed.

Note:           If individual preset values have been set during current operation by a user, the parameter should then be set to "no" to ensure that the individual positions are retained!

**Position 1 [%]; Louvre 1 [%]**

**Position 2 [%]; Louvre 2 [%]**

**Position 3 [%]; Louvre 3 [%]**

**Position 4 [%]; Louvre 4 [%]**

Options: 0..20..40..60..80..100

“0”: top / opened

“...”: intermediate position

“100”: bottom / closed

With this parameter, the preset position (position and louvre setting) is set. The parameter “Louvre X” is only displayed in the “Blinds” mode.



### 3.2.11 Parameter window "Auto 1"

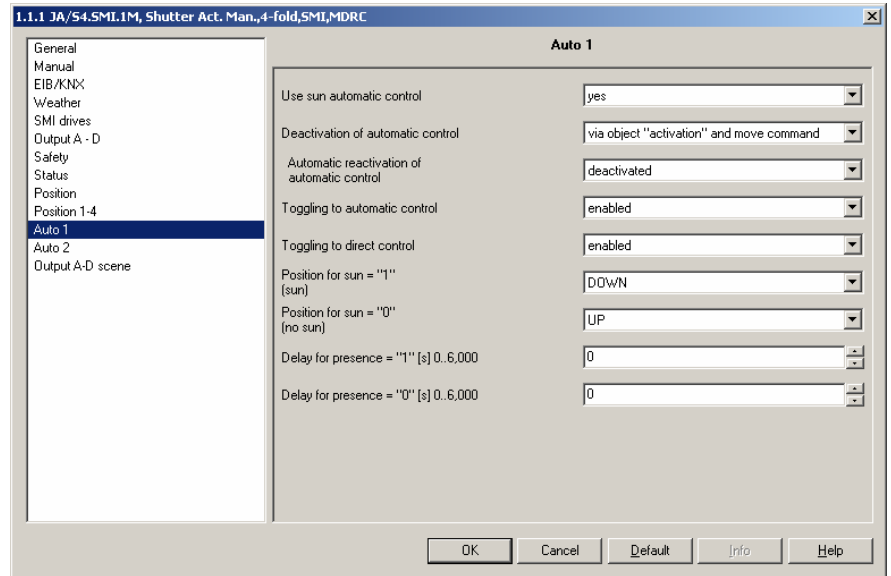

Fig. 15: Parameter window "Auto 1"

#### Use sun automatic control

Options:       - *no*  
                  - *yes*

Automatic control of the sun protection function is activated with this parameter.

Together with other EIB/KNX components, a very convenient automatic control function can be established with the Shutter Actuator. This automatic control is activated individually for every output and controls the shutter/blind according to the intensity of the sun's rays. The shutter/blind is moved automatically to the ideal position providing shade in accordance with the intensity and direction in which the sun is shining.

For example, the blinds can be moved upwards if the sunshine is very weak or if the window concerned is in shadow. Accordingly, the room receives as much light as possible without needing to be subject to direct sunshine (also refer to chapter 4.4.1)

*yes*: The communication objects "Activation of aut. control" and "Sun" as well as the parameters of the parameter window "Auto 1" and the parameter window "Auto 2" are displayed.

**Deactivation of automatic control**

- Options:
- *via object "activation"*
  - *via object "activation" and move command*

The Shutter Actuator only observes incoming telegrams for the "Sun automatic control" communication objects (also refer to chapter 3.3.1, objects no. 10-17) if automatic control has been activated. The automatic control is activated by a telegram with the value "1" at the communication object "Activation of aut. control".

The automatic control is deactivated by a telegram with the value "0" at the same communication object. With this parameter you set if the automatic control is also deactivated via a movement command, e.g. by an up or down movement command.

*via object "activation"*: The automatic control is activated and deactivated exclusively by a telegram to the communication object "Activation of aut. control". If automatic control is activated, the incoming telegrams to the direct communication objects are not carried out. After deactivation of automatic control, the shutter/blind remains in its current position and can be controlled again via direct communication objects.

*via object "activation" and move command*: Incoming telegrams to direct communication objects lead to deactivation of automatic control and are carried out immediately. This option is particularly suitable when the automatic control is activated via a central command and is to be deactivated again without additional push button operations. The parameter "Automatic reactivation of automatic control" is displayed.

Note: Direct objects are objects which can be used to initiate a movement command without a delay:

- Move blinds Up-Down
- Louvre adj./ Stop Up-Down
- Blinds Up-Down limited
- Move to position 0..255
- Move louvre 0..255
- Move to position 1/2
- Move to position 3/4
- Scene

**Automatic reactivation of automatic control**

Options:           - *deactivated*  
                      - *activated*

If automatic control has been deactivated via a telegram at the direct communication objects, it can be automatically reactivated after the parameterised time has elapsed. This function is also particularly suitable if no additional button is available for the activation or deactivation of automatic control.

*activated*: The parameter "Time to reactivate automatic control automatically" is displayed.

**Time to reactivate automatic control automatically [min.]**

Options:           10...6.000 (300)

Used for setting the time for automatic reactivation of automatic control. If automatic control is interrupted during the parameterised time by a direct communication object, the parameterised time for automatic reactivation of automatic control starts counting again from "0" (retriggering).

Note:             A changing of this parameter value will only take effect after a following deactivation of the automatic control.

**Toggling to automatic control  
Toggling to direct control**

Options:           - *enabled*  
                      - *via object enable/ disable*

Via this object you determine if toggling to automatic control or direct control is enabled or disabled.

*via object enable/ disable*: The communication object "Enable/disable automatic" or "Enable/ block direct control" is displayed.

**Position for sun = "1" (sun)**

Options:           - *no reaction*  
                      - *UP*  
                      - *DOWN*  
                      - *STOP*  
                      - *Position 1 to Position 4*  
                      - *Receive position and louvre via object*  
                          (*only for "Blinds" mode*)  
                      - *Receive only louvre via object*  
                          (*only for "Blinds" mode*)  
                      - *Receive position via object*  
                          (*only for "Shutter" mode*)

With activated automatic control, the Shutter Actuator can either control the position of the shutter/blind using a fixed parameterised value (e.g. "UP", "DOWN" or "Position X") or via an incoming telegram and the louvre setting dependent on the situation ("Receive position via object").

*no reaction/ UP/ DOWN/ STOP/ Position X*: These options are particularly suitable if the Shutter Actuator is only controlled by a brightness sensor. The shutter only moves upwards if the brightness value falls below the threshold (Sun = "0") and upwards, or in a parameterised position, if the brightness value is exceeded (Sun = "1").

*Receive position and louvre via object:* These options are particularly suitable if the Shutter Actuator is controlled by shutter module JSB/S. The Shutter Actuator receives the individual sunshine intensity taking consideration of the position of the sun on the communication object "Sun" for every shutter/blind, as well as the brightness value and possible sources of shadow. Furthermore, the communication objects "Move to pos. for sun 0..255" and "Adjust louvres for sun 0..255" are displayed, at which the Shutter Actuator receives the ideal shading position and louvre setting. With this function, a position with as much diffuse light as possible and sunlight tracking control are established (also refer to chapter 4.4 "Automatic control").

*receive only louvre via object:* This object is particularly suitable if the louvre angle is controlled via the shutter module JSB/S but the shutter/blind continues to be controlled via the communication objects "Move blinds Up-Down" and "Louvre adj./ Stop Up-Down". If this option is set, a telegram to these communication objects only leads to deactivation of automatic control, if the shutter/blind is at rest and a telegram is received at the communication object "Louvre adj./ Stop Up-Down" (precondition: For the parameter "Deactivation of automatic control" the option "via object "activation" and move command" must be set). The communication object "Adjust louvres for sun 0..255" is displayed.

Note: A louvre adjustment is not carried out if the shutter/blind is in its upper end position. However, the louvre setting is saved internally so that for example, the calculated louvre position is adopted after a positioning command.

#### **Position for sun = "0" (no sun)**

Options:

- no reaction
- UP
- DOWN
- STOP
- Position 1 to Position 4
- same as sun = '1'

With activated automatic control, the Shutter Actuator can either control the position of the shutter/blind using a fixed parameterised value (e.g. "UP", "DOWN" or "Position X") or via an incoming telegram and the louvre setting dependent on the situation ("Receive position via object").

*on reaction/ UP/ DOWN/ STOP/ Position X:* These options are particularly suitable if the Shutter Actuator is only controlled by a brightness sensor. The shutter or the blind only moves upwards if the brightness value falls below the threshold (Sun = "0") and upwards or in a parameterised position, if the brightness value is exceeded (Sun = "1").

*same as sun = '1'* If this option is selected, the shutter/blind moves in accordance with the setting of the parameter "Position for sun = '1'".

**Delay for sun = 1 [s]****Delay for sun = 0 [s]**

Options: 0...6.000 (0)

In order to prevent the shutter/blinds continuously moving up and down in changeable weather, the reaction can be delayed with the communication object "Sun". It is possible for example to move the shutter/blind immediately to the shading position without any delay as soon as the sun's rays are detected. If however the sun is briefly covered by a cloud, the Shutter Actuator will wait for the parameterised delay time. If the sun returns, the shutter/actuator will remain in the shading position. If the sun is absent (behind clouds/overcast) for the entire time, the Shutter Actuator will move to the parameterised position "Position for sun= 0".

Note: The delay times can also be set in the brightness sensor and in the shutter module. These different delay times should be optimised and co-ordinated to one another in order to retain the required function.

### 3.2.12 Parameter window "Auto 2"

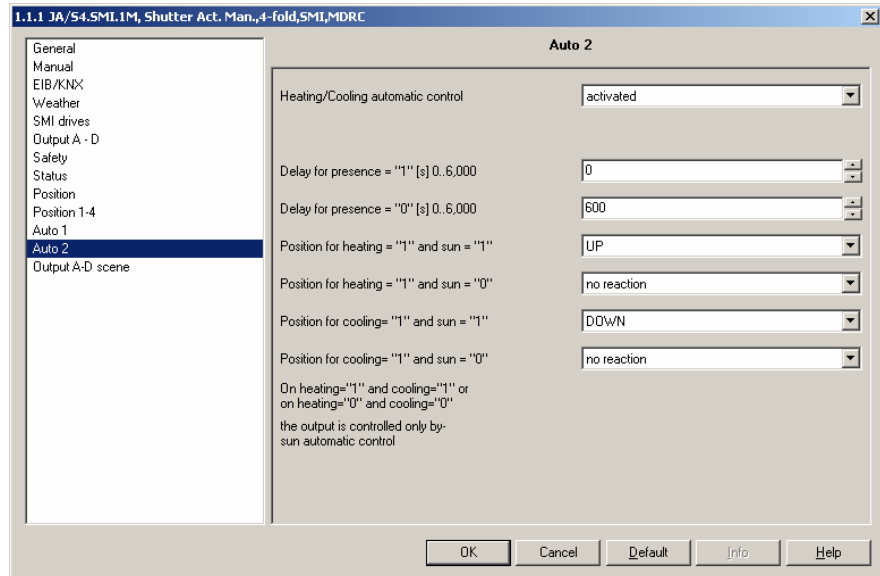

Fig. 16: Parameter window "Auto 2"

#### Heating/Cooling automatic control

Options:           - *deactivated*  
                      - *activated*

Automatic heating/cooling control is activated with this parameter.

The automatic heating/cooling control function controls the shutter/blinds according to the sun's rays and the required energy input requirement into the room. The shutter/blind is moved to the ideal shading position to ensure optimum heating/cooling.

Thus, for example, the blind can be opened during the heating phase of the sun to provide additional warmth to the room, and at night the textile inner blind can be used to reduce cooling in the room. On the other hand the shutters/blinds can be lowered during the cooling phase to avoid additional heating of the room (also refer to chapter 4.4.2).

*activated*: The communications objects "Heating", "Cooling" and "Presence" as well as the parameter window "Auto 2" are displayed.

#### Delay for presence = "1" [s]

#### Delay for presence = "0" [s]

Options:           0...6.000     0 (Delay for presence = "1")  
  600 (Delay for presence = "0")

The automatic heating/cooling function is an extension of the sun protection control and can only be activated if automatic control is activated. It is possible to toggle between automatic sun protection and automatic heating/cooling via the communication object "Presence". If persons are located in the room, the automatic sun control is active. If no persons are present, automatic heating/cooling control is activated.

The communication object "Presence" can be linked for example with a presence detector which toggles automatically between both methods of automatic control, or which switches on the automatic heating/cooling control with a central command at the weekend in an office building.

In order to prevent the shutter/blinds from continuously moving up and down as soon as a person enters or leaves the room, the reaction of the communication object "Presence" can be delayed. The shutter/blinds are moved to the automatic sun control position as soon as someone enters the room, but automatic heating/cooling control is only activated if no one has been present in the room for more than 10 minutes.

**Position for heating = "1" and sun = "1"**

**Position for heating = "1" and sun = "0"**

**Position for cooling = "1" and sun = "1"**

**Position for cooling = "1" and sun = "0"**

Options:

- *no reaction* (with sun = "0")
- *UP* (with heating = "1" and sun = "1")
- *DOWN* (with cooling = "1" and sun = "1")
- STOP
- Position 1 to Position 4

For setting the behaviour with sun = "1" (sun) or with sun = "0" (no sun) during the heating phase or during the cooling phase.

The heating phase (heating = "1") or the cooling phase (cooling = "1") is triggered preferably with an external temperature sensor or by a year time switch.

Example of an external temperature sensor:

Heating phase: less than 10°C

Cooling phase: greater than 20°C

Example of a year time switch:

Heating phase: November - March

Cooling phase: June - August

If both heating operation and cooling operation are simultaneously activated or none of the operating modes are activated, then the automatic heating/cooling control is deactivated until one defined state (heating or cooling operation) is in operation. The shutter/blinds are automatically controlled until then using automatic sun control.

Note: If automatic heating/cooling control is to be programmed but no automatic sun control is to be programmed, the communication object "Presence" has to remain without a logic function. Accordingly, the default value "0" has to be automatically present in this object. Thus automatic heating/cooling control is immediately activated, if automatic mode has been activated via the communication object "Activation of aut. control".

### 3.2.13 Parameter window “Output A-D scene”

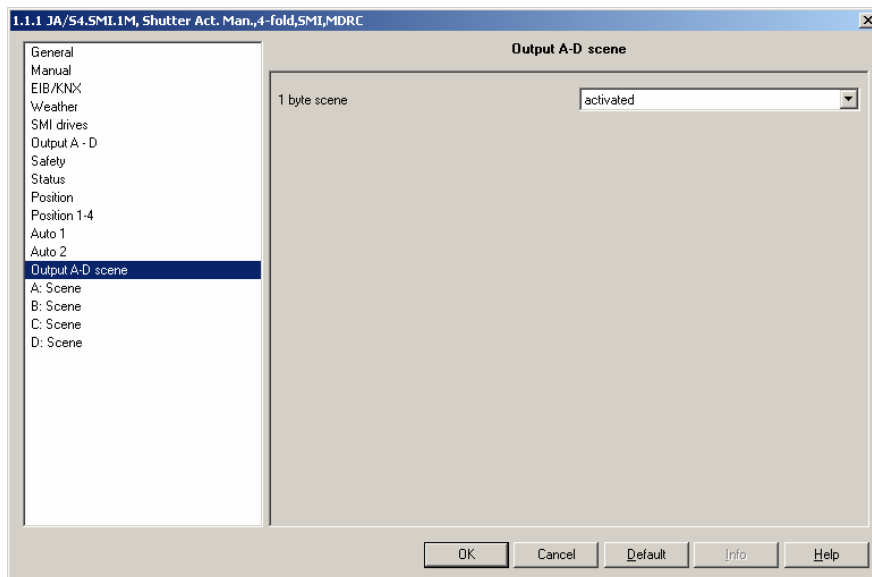

Fig. 17: Parameter window “Output A-D scene”

#### 1 byte scene

Options:           - *deactivated*  
                      - *activated*

*activated*: The parameter windows A-Scene, B-Scene, C-Scene and D-Scene are displayed.



### 3.2.14 Parameter window “A-D scene”

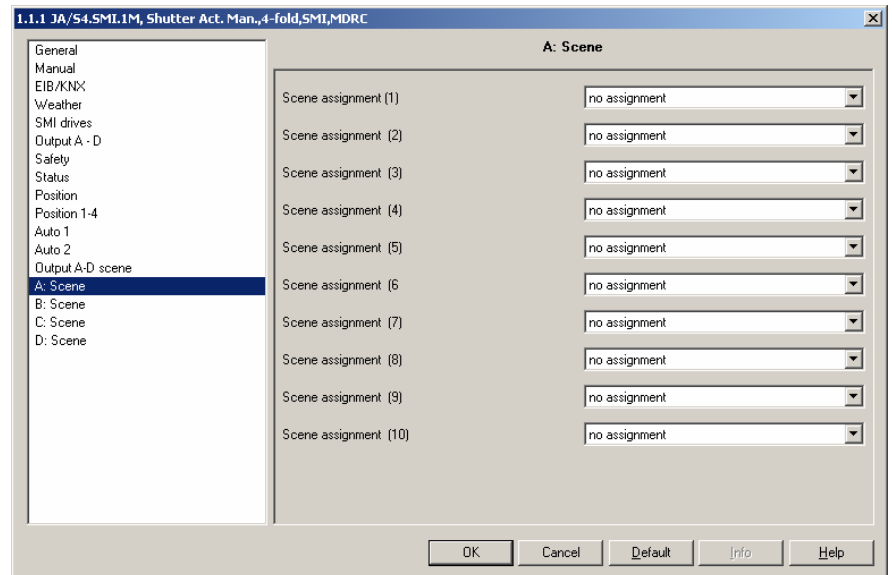

Fig. 18: Parameter window “A-D scene”

#### Scene assignment (1) Scene assignment (2) etc.

Options:           - no assignment  
                      - Scene 1 ... Scene 64

With the scene function, up to 64 different scenes are managed via a single group address. With this group address all slaves who are integrated into a scene are linked via a 1-byte communication object. The following information is contained in a telegram:

- Number of the scene (1 ... 64) as well as
- Command: recall scene or save scene.

Each shutter/blind can be integrated in up to 10 scenes. In total, up to 40 scene assignments are possible for a 4-fold Shutter Actuator. Thus, for example, all roller blinds can be opened in the morning via a scene and closed in the evenings or shutters/blinds can be integrated into lightscenes.

If a telegram is received at the “Scene” communications object, all outputs assigned to the sent scene number will then move to the saved scene position or the current position will be saved as a new scene position.

**Example**

The first three outputs of the Shutter Actuator are assigned to the following scenes. The preset values have been saved with the last corresponding setting of the scenes.

<u>Output</u>	<u>Scene no.</u>	<u>Default position</u>	<u>Default louvre</u>
A	5	20%	50%
A	9	47%	30%
A	45	70%	80%
B	5	20%	50%
B	37	82%	65%
B	45	75%	31%
B	78	65%	77%
C	10	80%	-

If scene no. 5 is now recalled, the blinds on outputs A and B will move to the saved preset positions and align the louvres in accordance with the saved preset value. The roller blind on output C is not assigned to scene no. 5 and therefore will not move.

If however scene 10 is retrieved, only the roller blind on output C will move to the saved preset position. As output C in this example is operated in the "Shutter" mode, the subsequent alignment of the louvres is not undertaken.

If the command "recall scene no. 5" to the position 20% / 50% has been last carried out on output A, and the user now wishes to use this position as the new preset value for scene no. 45, then the request "Save scene" as well as the no. 45 are sent with the push button action via the EIB/KNX. The shutter/blind does not move. The current position is now saved as the new preset value for scene no. 45 (see the table below) and used the next time the scene is recalled.

<u>Output</u>	<u>Scene no.</u>	<u>Default position</u>	<u>Default louvre</u>
A	5	20%	50%
A	9	47%	30%
A	45	20%	50%

**Advantages**

The 1-byte scene offers a few advantages in comparison to conventional scene programming. On the one hand, only a single telegram which is received by all participants in the scene and implemented accordingly, is sent on the bus to retrieve a scene. The target position is saved in the actuator and does not need to be transferred via the EIB/KNX with each recall. Only one group address is required for up to 64 scenes. This simplifies the engineering involved and reduces the bus load.

**Reaction on bus voltage failure and programming**

The saved scene values are retained with the bus voltage failure, as is the case, if only the parameters are loaded when programming. If the complete application must be reloaded during programming, then the scene value is reset to the position "right at the top", i.e. preset position = 0 % and preset louvres = 0 %.

### 3.3 Communication objects

#### 3.3.1 Communication objects “Output A-D”

Number	Name	Object Function	Length	C	R	W	T	U
1	Output A	Move blinds Up-Down	1 bit	C	-	W	-	-
2	Output A	Louvre adj./ Stop Up-Down	1 bit	C	-	W	-	-
3	Output A	Blinds Up-Down limited	1 bit	C	-	W	-	-
4	Output A	Move to position 0..255	1 Byte	C	-	W	-	-
5	Output A	Move louvre 0..255	1 Byte	C	-	W	-	-
6	Output A	Move to position 1/2	1 bit	C	-	W	-	-
7	Output A	Move to position 3/4	1 bit	C	-	W	-	-
8	Output A	Set position 1/2	1 bit	C	-	W	-	-
9	Output A	Set position 3/4	1 bit	C	-	W	-	-
10	Output A	Activation of aut. Control	1 bit	C	-	W	T	U
11	Output A	Sun	1 bit	C	-	W	T	U
12	Output A	Move to pos. for sun 0..255	1 Byte	C	-	W	T	U
13	Output A	Adjust louvres for sun 0..255	1 Byte	C	-	W	T	U
14	Output A	Presence	1 bit	C	-	W	T	U
15	Output A	Heating	1 bit	C	-	W	T	U
16	Output A	Cooling	1 bit	C	-	W	T	U
17	Output A	Enable/disable automatic	1 bit	C	-	W	T	U
18	Output A	Enable/ block direct control	1 bit	C	-	W	T	U
19	Output A	Block	1 bit	C	-	W	-	-
20	Output A	Forced operation	2 bit	C	-	W	-	-
21	Output A	Teleg. status of position 0..	1 Byte	C	R	-	T	-
22	Output A	Teleg. status louvre 0..255	1 Byte	C	R	-	T	-
23	Output A	Teleg. status of upper pos.	1 bit	C	R	-	T	-
24	Output A	Teleg. status of lower pos.	1 bit	C	R	-	T	-
25	Output A	Teleg. status of operation	1 bit	C	R	-	T	-
26	Output A	Teleg. status of aut. control	1 bit	C	R	-	T	-
27	Output A	Teleg. status byte	1 Byte	C	R	-	T	-
28	Output A	Teleg. status SMI failure	1 bit	C	R	-	T	-
29	Output A	Teleg. status number of drive	1 bit	C	R	-	T	-
30	Output A	Teleg. diagnostic byte	1 Byte	C	R	-	T	-

Fig. 19: Communication objects “Output A-D”

No.	Function	Object name	Data type	Flags
1	<b>Move blinds Up-Down</b> ("Blinds" mode) <b>Move shutter Up-Down</b> ("Shutter" mode)	<b>Output A</b>	<b>1 Bit EIS1</b> <b>DPT 1.008</b>	<b>C, W</b>
<p>If a telegram with the value "0" is received at this communication object, the shutter/blind is moved upwards. If a telegram with the value "1" is received, the shutter/blind is moved downwards. The shutter/blind stops automatically if the upper or lower end position is reached.</p> <p>Telegram value: "0": UP "1": DOWN</p>				
2	<b>Louvre adjustment/Stop</b> ("Blinds" mode) <b>Stop</b> ("Shutter" mode)	<b>Output A</b>	<b>1 Bit EIS1</b> <b>DPT 1.007</b>	<b>C, W</b>
<p>If the shutter/blind is moving, the movement stops if a telegram is received at this communication object, regardless of if a "1" or a "0" is received.</p> <p>"Blinds" mode: When the shutter/blind is at rest and a telegram is received at this communication object, a louvre adjustment upwards ("0") or downwards ("1") is carried out.</p> <p>"Shutter" mode: When the shutter/blind is at rest and a telegram is received, no action is undertaken.</p> <p>Telegram value: "0": Stop/ Louvre adj. up "1": Stop/ Louvre adj. down</p>				
3	<b>Blinds Up-Down limited</b> ("Blinds" mode) <b>Shutter Up-Down limited</b> ("Shutter" mode)	<b>Output A</b>	<b>1 Bit EIS1</b> <b>DPT 1.008</b>	<b>C, W</b>
<p>If a telegram with the value "0" is received at this communication object, the shutter/blind is moved upwards. If a telegram with the value "1" is received, the shutter/blind is moved downwards. The shutter/blind stops automatically if the parameterised upper or lower limit is reached.</p> <p>Telegram value: "0": UP "1": AB</p>				
4	<b>Move to position 0..255</b>	<b>Output A</b>	<b>1 Byte EIS6</b> <b>DPT 5.001</b>	<b>C, W</b>
<p>If a telegram is received at this communication object, the shutter/blind is moved to the corresponding position of the received value.</p> <p>Telegram value: "0": Top "...": Intermediate position "255": Bottom</p> <p>After the target position is reached, the louvres will assume the same position they were in before the movement started. If a telegram is received during movement at the communication object "Move louvre 0..255", then the louvres are set to the corresponding received value after the target position has been reached.</p>				
5	<b>Move louvre 0..255</b> ("Blinds" mode)	<b>Output A</b>	<b>1 Byte EIS6</b> <b>DPT 5.001</b>	<b>C, W</b>
<p>If a telegram is received at this communication object, the louvres are then positioned in accordance with the received value.</p> <p>Telegram value: "0": Louvre fully opened "...": Intermediate position "255": Louvre fully closed</p> <p>If the shutter/blind is currently moving, the movement will continue to the target position and positioning of the louvres is then undertaken.</p>				

No.	Function	Object name	Data type	Flags
<b>6</b> <b>7</b>	<b>Move to position 1/2</b> <b>Move to position 3/4</b>	<b>Output A</b> <b>Output A</b>	<b>1 Bit EIS1</b> <b>DPT 1.006</b>	<b>C, W</b>
<p>If a telegram is received at this communication object, then the shutter/blind is moved to the saved preset position. In the "Blinds" mode, the louvre positioning is undertaken according to the saved preset value after the position has been reached.</p> <p>If a telegram with the value "0" is received, the shutter/blind is moved to position 1 (or position 3). If a telegram with the value "1" is received, the shutter/blind is moved to position 2 (or position 4)</p> <p>Telegram value:      "0":    Move to position 1   Move to position 3   "1":    Move to position 2   Move to position 4</p>				
<b>8</b> <b>9</b>	<b>Set position 1/2</b> <b>Set position 3/4</b>	<b>Output A</b> <b>Output A</b>	<b>1 Bit EIS1</b> <b>DPT 1.006</b>	<b>C, W</b>
<p>If a telegram is received at this communication object, the current position of the shutter/blind is accepted as the new preset value.</p> <p>If a telegram with the value "0" is received, then the current position is saved as the preset value for position 1 (or position 3). If a telegram with the value "1" is received, then the current position is saved as the preset value for position 2 (or position 4). If the positions 1 or 2 are recalled (or positions 3 or 4), you will now move to the new preset values.</p> <p>The changed preset values are retained with a bus voltage failure. With the programming of the Shutter Actuator, it is possible to set via a parameter if the saved values should be overwritten by the parameterised values.</p> <p>Telegram value:      "0":    Set position 1 or   Set position 3   "1":    Set position 2 or   Set position 4</p>				
<b>10</b>	<b>Activation of aut. control</b>	<b>Output A</b>	<b>1 Bit EIS1</b> <b>DPT 1.011</b>	<b>C, W, T, U</b>
<p>If a telegram with the value "1" is received at this communication object, "Activation of aut. control" is activated. The output is controlled via the "Automatic" communication objects "Sun", "Presence", "Heating" and "Cooling" as well as "Move to pos. for sun 0..255" and "Adjust louvres for sun 0..255".</p> <p>If a telegram with the value "0" is received, the shutter/blind remains in the current position and no longer reacts to incoming telegrams at the "Automatic" communication objects.</p> <p>Telegram value:      "0":    Automatic control deactivated   "1":    Automatic control activated</p>				

No.	Function	Object name	Data type	Flags
11	Sun	Output A	1 Bit EIS1 DPT 1.001	C, W, T, U
<p>Incoming telegrams at this communication object are only considered if automatic control is activated.</p> <p>If a telegram with the value "1" is received at the communication object "Sun", the shutter/blind will move to the parameterised position "Position for sun = 1". If a telegram with the value "0" is received, the shutter/blind will move to the parameterised position "Position for sun = 0".</p> <p>The reaction to incoming telegrams can be delayed in its execution via the parameter "Delay for sun= X", in order to prevent the shutter/blinds continuously moving up and down in changeable weather. If a telegram with the opposing value is received within the delay time, the "Position for sun = 1" is not executed and the shutter/blind remains in the "Position for sun = 0" or vice versa.</p> <p>If the option "receive position via 8 bit value" is set as "Position for sun = X", after the delay has elapsed the output will move to the position which was last received at the communication objects "Move to pos. for sun 0..255" ("Blinds" and "Shutter" mode) as well as "Adjust louvres for sun 0..255" (only for "Blinds" mode).</p> <p>Telegram value:    "0":   no sun                       "1":   sun</p>				
12	Move to pos. for sun 0..255	Output A	1 Byte EIS6 DPT 5.001	C, W, T, U
<p>Incoming telegrams at this communication object are only executed if automatic control is activated and if a "1" has been received at the "Sun" communication object. The shutter is then positioned to correspond with the received value.</p> <p>Telegram value:    "0":   Top                       "...":   Intermediate position                       "255": Bottom</p> <p>After the target position is reached, the louvres will assume the same position they were in before the movement started. If a telegram is received during movement at the communication object "Adjust louvres for sun 0..255", then the louvres are set to the corresponding received value after the target position has been reached.</p>				
13	Adjust louvres for sun 0...255 ("Blinds" mode)	Output A	1 Byte EIS6 DPT 5.001	C, W, T, U
<p>Incoming telegrams at this communication object are only executed if automatic control is activated and if a "1" has been received at the "Sun" communication object. The louvres are then positioned to correspond with the received value.</p> <p>Telegram value:    "0":   Louvre fully opened                       "...":   Intermediate position                       "255": Louvre fully closed</p> <p>If the shutter/blind is currently moving, the movement will continue to the target position and positioning of the louvres is then undertaken.</p>				

No.	Function	Object name	Data type	Flags
14	Presence	Output A	1 Bit EIS1 DPT 1.002	C, W, T, U
<p>Incoming telegrams at this communication object are only considered if automatic control is activated.</p> <p>If a telegram with the value "1" is received at this communication object, the automatic sun control is activated and the shutter/blinds are controlled in accordance with the parameterised "Position for sun = X".</p> <p>If a telegram with the value "0" is received at this communication object, then automatic heating/cooling is activated and the shutter/blind is controlled in accordance with the parameterised "Position for heating = "1" and sun = "X" or "Position for cooling = "1" and sun = "X".</p> <p>The reaction to incoming telegrams can be delayed in its execution via the parameter "Delay for presence = X", in order to prevent the shutter/blinds continuously moving up and down when people enter and leave the room frequently. If a telegram with the opposing value is received within the delay time, the heating/cooling target position is not moved to and the shutter/blind remains in the automatic sun control target position or vice versa.</p> <p>Telegram value: "0": no one present (→ Automatic heating/cooling) "1": persons present (→ Automatic sun control)</p> <p>Pay attention to the telegram values with objects 15/16 (heating/cooling)!</p> <p> If automatic heating/cooling control is to be programmed but without automatic sun control, the communication object "Presence" has to remain without a logic function. Accordingly, the preset value "0" has to be automatically present in this communication object. Automatic heating/cooling control is thus immediately activated, if automatic control has been activated via the communication object "Activation of aut. control".</p>				
15 16	Heating Cooling	Output A Output A	1 Bit EIS1 DPT 1.011	C, W, T, U
<p>Incoming telegrams at these communication objects are only executed if automatic control is activated and if a "0" has been received at the "Presence" communication object.</p> <p>If a telegram with the value "1" is received at the communication object "Heating", then the output will move to the parameterised "Position for heating = "1" and sun = "1" or "Position for heating = "1" and sun = "0".</p> <p>If a telegram with the value "1" is received at the communication object "Cooling", then the output will move to the parameterised "Position for cooling = "1" and sun = "1" or "Position for cooling = "1" and sun = "0".</p> <p>If both communication objects have last received a "0" or if both have received a "1", then the automatic heating/cooling function is deactivated and the output is controlled via automatic sun control.</p> <p>Telegram value: "0": do not heat/do not cool "1": heating/cooling</p>				
17	Enable/disable automatic	Output A	1 Bit EIS1 DPT 1.001	C, W, T, U
<p>If a telegram with the value "1" is received at this communication object, the automatic control is deactivated and the output can only be controlled "directly" via communication objects. The automatic control can no longer be activated via the "Activation of aut. control" communication object.</p> <p>If a telegram with the value "0" is received at this communication object, the automatic control can be reactivated again for the corresponding output.</p> <p>Telegram value: "0": Enable automatic "1": Disable automatic</p>				

No.	Function	Object name	Data type	Flags
18	Enable/ block direct control	Output A	1 Bit EIS1 DPT 1.001	C, W, T, U
<p>If a telegram with the value "1" is received at this communication object, the incoming telegrams will not be executed at the communication objects no. 1 to 9.</p> <p>Telegram value: "0": Enable direct control "1": Block direct control</p>				
19	Block	Output A	1 Bit EIS1 DPT 1.011	C, W
<p>If a telegram with the value "1" is received at this communication object, then the shutter/blind is moved to the parameterised "Position during blocking" and operation is blocked.</p> <p>If a telegram with the value "0" is received after a telegram with the value "1", the shutter/blind is moved to the parameterised "Position on reset of weather alarm, blocking and forced operation" and operation is re-enabled.</p> <p>Telegram value: "0": Enable operation "1": Operation disabled</p>				
20	Forced operation	Output A	2 Bit EIS8 DPT 2.002	C, W
<p>If a telegram with the value "2" (binary 10) is received at this communication object, then the shutter/blind is opened and operation is blocked.</p> <p>If a telegram with the value "3" (binary 11) is received at this communication object, then the shutter/blind is closed and operation is also blocked.</p> <p>If a telegram with the value "0" (binary 00) or "1" (binary 01) is received after a "2" or a "3", then the shutter/blind is moved to the "Position on reset of weather alarm, blocking and forced operation" position and re-enabled.</p> <p>Telegram value: "0" (binary 00): Enable operation "1" (binary 01): Enable operation "2" (binary 10): UP/operation disabled "3" (binary 11): DOWN/operation disabled</p>				
21	Telegr. status position 0...255	Output A	1 Byte EIS6 DPT 5.001	C, R, T
<p>The Shutter Actuator sends the current position of the shutter/blind to this communication object.</p> <p>Telegram value: "0": Top "...": Intermediate position "255": Bottom</p> <p>The current position is sent after completion of a movement. If a new movement has commenced in the meantime, the current position is sent only after completion of the last movement.</p>				
22	Telegr. status louvre 0...255 ("Blinds" mode)	Output A	1 Byte EIS6 DPT 5.001	C, R, T
<p>The Shutter Actuator sends the current position of the louvre setting to this communication object.</p> <p>Telegram value: "0": Louvre fully opened "...": Intermediate position "255": Louvre fully closed</p> <p>The current position is sent after completion of a movement. If a new movement has commenced in the meantime, the current position is sent only after completion of the last movement.</p>				



No.	Function	Object name	Data type	Flags
23	<b>Telegr. status position top</b>	<b>Output A</b>	<b>1 Bit EIS1 DPT 1.008</b>	<b>C, R, T</b>
<p>The Shutter Actuator sends information to this communication object about whether the shutter/blind is in the upper limit position.</p> <p>Telegram value:    "0": Shutter/blind not in upper end position                       "1": Shutter/blind in upper end position</p> <p>The upper status position is sent after the upper end position is achieved or exited.</p>				
24	<b>Telegr. status position bottom</b>	<b>Output A</b>	<b>1 Bit EIS1 DPT 1.008</b>	<b>C, R, T</b>
<p>The Shutter Actuator sends information to this communication object about whether the shutter/blind is in the lower limit position.</p> <p>Telegram value:    "0": Shutter/blind not in lower end position                       "1": Shutter/blind in lower end position</p> <p>The lower status position is sent after the lower end position is achieved or exited.</p>				
25	<b>Telegr. status operation</b>	<b>Output A</b>	<b>1 Bit EIS1 DPT 1.002</b>	<b>C, R, T</b>
<p>The Shutter Actuator sends information to this communication object about whether the shutter/blind operation is enabled or disabled.</p> <p>This operation is disabled if either one of the "Safety" functions has been activated (e.g. wind alarm) or if the Shutter Actuator has been toggled to manual operation.</p> <p>Telegram value:    "0": Enable operation                       "1": Operation disabled</p> <p>The operation status is sent when a change occurs.</p>				
26	<b>Telegr. status automatic</b>	<b>Output A</b>	<b>1 Bit EIS1 DPT 1.011</b>	<b>C, R, T</b>
<p>The Shutter Actuator sends information to this communication object about whether automatic control has been activated.</p> <p>Telegram value:    "0": Automatic not activated                       "1": Automatic activated</p> <p>The automatic status is sent when a change occurs.</p> <p> If the Shutter Actuator is toggled to manual operation when automatic control is activated, a "0" is sent to this communication object. A "0" is also sent if a "Safety" function has been activated (e.g. wind alarm) when automatic control is activated.</p>				

No.	Function	Object name	Data type	Flags
27	Telegr. status byte	Output A	1 Byte non EIS DPT 6.020	C, R, T
<p>Using this communication object, the Shutter Actuator sends information regarding the mode in which the drive is currently operating. Only one mode can be activated at any time.</p> <p>Telegram code: 76543210</p> <p>Bit no.</p> <p>7: Automatic heating/cooling 6: Automatic sun protection 5: Wind alarm 4: Rain alarm 3: Frost alarm 2: Forced positioning 1: Block 0: Manual operation</p> <p>Telegram value: "0": not activated "1": activated</p> <p>The status byte is sent in the event of a change.</p> <p>A status byte code table with all possible combinations can be found in the appendix (see chapter 5.1).</p>				
28	Telegr. status SMI failure	Output A	1 Bit EIS1 DPT 1.011	C, R, T
<p>Using this communication object, the Shutter Actuator sends a telegram with the value "1", if no drive can be detected on the SMI output or the 230 V operating voltage has failed.</p> <p>Telegram value: "0": SMI o.k. "1": SMI or 230 V has failed</p> <p>The SMI failure is sent in the event of a change.</p>				
29	Telegr. status number of drives	Output A	1 Bit EIS1 DPT 1.011	C, R, T
<p>Using this communication object, the Shutter Actuator sends a telegram with the value "1", if the number of connected drives per SMI output deviates from the number of parameterised drives.</p> <p>Telegram value: "0": Number of drives o.k. "1": Number of drives too high/ too low</p> <p> If more than four drives are connected to a channel, the actuator will only carry out alarm and safety functions. No commands are carried out via the EIB/KNX. Operation of the manual buttons on the front of the device is still possible.</p>				

No.	Function	Object name	Data type	Flags
30	Telegr. diagnostic byte	Output A	1 Byte non EIS DPT 6.020	C, R, T
<p>Using this communication object, the Shutter Actuator sends information concerning the current state of the drive on the EIB/KNX.</p> <p>Telegram code: 76543210</p> <p>7: No communication 6: Motor moves up 5: Motor moves down 4: Motor fault 3: Short circuit on SMI (hardware fault) 2: More drives detected than configured 1: Less drives detected than configured 0: More than 4 drives detected on SMI</p> <p>Telegram value: "0": not activated "1": activated</p> <p>The diagnostics byte is sent in the event of a change. A diagnostics byte code table with all possible combinations can be found in the appendix (see chapter 5.2).</p>				
No.	Function	Object name	Data type	Flags
31-60	Analog output A	Output B		
61-90	Analog output A	Output C		
91-120	Analog output A	Output D		

### 3.3.2 Communication objects “General”

Number	Name	Object Function	Length	C	R	W	T	U
121	Output A-D	Telegr. status of auxiliary vo	1 bit	C	R	-	T	-
122	Output A-D	Enable/ block manual operation	1 bit	C	-	W	-	-
123	Output A-D	Telegr. status of man. operati	1 bit	C	R	-	T	-
124	Output A-D	Wind alarm no. 1	1 bit	C	-	W	T	U
125	Output A-D	Wind alarm no. 2	1 bit	C	-	W	T	U
126	Output A-D	Wind alarm no. 3	1 bit	C	-	W	T	U
127	Output A-D	Rain alarm	1 bit	C	-	W	T	U
128	Output A-D	Frost alarm	1 bit	C	-	W	T	U
129	Output A-D	Scene	1 Byte	C	-	W	-	-
130	Output A-D	Time for automatic reactivatio	2 Byte	C	-	W	-	-
131	Output A-D	Delay for sun = 1	2 Byte	C	-	W	-	-
132	Output A-D	Delay for sun = 0	2 Byte	C	-	W	-	-
133	Output A-D	Delay for presence=1	2 Byte	C	-	W	-	-
134	Output A-D	Delay for presence=0	2 Byte	C	-	W	-	-

Fig. 20: Communication objects “General”

No.	Function	Object name	Data type	Flags
121	<b>Telegr. status external supply</b>	<b>Output A-D</b>	<b>1 Bit EIS1 DPT 1.005</b>	<b>C, R, T</b>
<p>The Shutter Actuator sends information to this communication object about whether the 230 V auxiliary voltage has been connected.</p> <p>Telegram value:    “0”: 230 V AC auxiliary voltage o.k.                       “1”: 230 V AC auxiliary voltage not o.k.</p> <p>If the 230 V AC auxiliary voltage fails, the SMI drives cannot be controlled and read. The auxiliary voltage status is sent when a change occurs.</p>				
122	<b>Man. control enable/disable</b>	<b>Output A-D</b>	<b>1 Bit EIS1 DPT 1.001</b>	<b>C, W</b>
<p>If a telegram with the value “1” is received at this communication object, the manual operation of the Shutter Actuator is deactivated. The Shutter Actuator cannot be toggled to manual operation using the “Man.” button. It is operated exclusively via the EIB/KNX.</p> <p>If a telegram with the value “0” is received at this communication object, the manual operation of the Shutter Actuator is activated. The Shutter Actuator can be toggled to manual operation using the “Man.” button.</p> <p>Telegram value:    “0”: Enable manual operation                       “1”: Disable manual operation</p> <p>If a Shutter Actuator is currently in manual operation and a telegram with the value “1” is received, the Shutter Actuator switches automatically to EIB/KNX operation.</p>				
123	<b>Telegr. status man. operation</b>	<b>Output A-D</b>	<b>1 Bit EIS1 DPT 1.001</b>	<b>C, R, T</b>
<p>The Shutter Actuator sends information to this communication object about whether the manual operation of EIB/KNX operation is activated.</p> <p>Telegram value:    “0”: EIB/KNX operation                       “1”: Manual operation</p> <p>The manual operation status is sent when a change occurs.</p>				

No.	Function	Object name	Data type	Flags
124 125 126 127 128	Wind alarm No. 1 Wind alarm No. 2 Wind alarm No. 3 Rain alarm Frost alarm	Output A-D Output A-D Output A-D Output A-D Output A-D	1 Bit EIS1 DPT 1.005	C, W, T, U
<p>These communication objects expect cyclic telegrams. If a telegram with the value "0" is received within the monitoring time, the operation of the shutter/blinds is enabled.</p> <p>If a telegram with the value "1" is received or no telegram is received during the monitoring period, the shutter/blind is moved to the parameterised "Position on wind alarm" (or with a rain alarm or frost alarm). The operation is inhibited.</p> <p>If after a weather alarm or after the monitoring period has been exceeded a telegram with the value "0" is received for the first time, the shutter/blind is moved to the "Position on reset of weather alarm" and the operation is re-enabled.</p> <p style="padding-left: 40px;">Telegram value: "0": do not heat/do not cool "1": heating/cooling</p> <p>The monitoring period is restarted after each telegram is received as well as after programming of the actuator and with bus voltage recovery.</p> <p>The three wind alarm communication objects are logically connected via an OR gate, i.e. if a wind alarm is present for one of the three communication objects (or a telegram is not received within the monitoring period), the shutter/blind moves to the parameterised "Position on wind alarm".</p>				
129	Scene	Output A-D	8-bit DPT 18.001	C, W
<p>With this communication object, each output can be integrated in up to ten scenes. With this communication object the number of the recalled scene is received as well as the information stating if the last saved value is to be used or if the current position is to be saved as a new preset value, using just a single telegram.</p> <p style="padding-left: 40px;">Telegram code: MXNNNNNN Telegram value: NNNNNN: 0...63: Scene number X: free (contains no information) M: "0": Recall scene "1": Store scene</p> <p>The saved scene values are retained with the bus voltage failure, as is the case, if only the parameters are loaded when programming. If the programming of the complete application is reloaded, then the scene value is reset to the "fully upwards" position. A 1-byte scene byte code table with all possible combinations can be found in the appendix (see chapter 1).5.3</p>				
130	Time for automatic reactivation	Output A-D	2 Byte EIS10 DPT 7.006	C, W
<p>With this information, the parameter "Time for automatic reactivation of automatic control" in minutes can be changed via the EIB/KNX.</p> <p style="padding-left: 40px;">Telegram value: 0: Automatic reactivation deactivated 1...6,000: Time to reactivate automatic control automatically</p> <p>On a bus voltage failure, the changed parameter settings are retained.</p> <p> Only telegram values between 0 and 6,000 minutes are valid. If another value is sent, the telegram does not initiate a parameter change.</p> <p>Also refer to chapter 3.2.11, parameter "Time to reactivate automatic control automatically"</p>				

No.	Function	Object name	Data type	Flags
131	Delay for sun = 1	Output A-D	2 Byte	C, W
132	Delay for sun = 0	Output A-D	EIS10	
133	Delay for presence = 1	Output A-D	DPT 7.005	
134	Delay for presence = 0	Output A-D		

With this communication object, the parameters of the same name can be modified via the EIB/KNX.

Telegram value: 0...6.000: (in seconds)

On a bus voltage failure, the changed parameter settings are retained.

 Only telegram values between 0 and 6,000 seconds are valid. If another value is sent, the telegram does not initiate a parameter change.

See also chapter 3.2.11, parameter "Delay for sun = 1 or 0"

## 4 Planning and application

### 4.1 Standard Motor Interface (SMI)

#### 4.1.1 Introduction

SMI is a digital interface for control of electrical blinds and shutter drives. Telegrams between the controller and drive are exchanged via SMI. The controller sends telegrams with movement commands to the drive; the drive sends status messages to the controller.

SMI certified products from different manufacturers are compatible and can be operated simultaneously in a system.

The Shutter Actuator JA/S 4.SMI.1M from ABB STOTZ-KONTAKT converts EIB/KNX telegrams to SMI telegrams and enables the control of SMI drives via the EIB/KNX. Furthermore, it receives status messages from SMI drives and can for example, pass on this information via the EIB/KNX to a visualisation system.

Shutter control with SMI has two advantages compared to the traditional shutter control using relay technology:

#### **1. The shutter/blind can be positioned more exactly**

The determination of the current position as well as the movement to a target position occurs directly on a SMI drive. Accordingly, inaccuracies associated with calculation of the position via travel times are no longer a factor.

#### **2. Status messages from the drive can be evaluated via the EIB/KNX**

The SMI drive not only determines the exact position but also other diagnostic and error messages, e.g.:

- Motor fault
- Motor moves down
- Motor moves up
- Communication diagnostics

### 4.1.2 Connection

The SMI drive is connected using a 5-lead cable with a maximum length of 350 metres. 3 leads are used for the phase, neutral and PE, and two leads are used for data transmission.

Up to 16 SMI drives can be connected to an SMI cable (max. 4 SMI drives per output with JA/S 4.SMI.1M). Three different operating modes are used to control the drives:

- Single operation
- Parallel operation with multiple addressing
- Parallel operation with single addressing\*

The Shutter Actuator JA/S 4.SMI.1M from ABB STOTZ-KONTAKT supports both of the first two modes. In contrast to the third operating mode, no SMI commissioning knowledge is necessary.

In single operation, only one SMI drive is connected to every output of the Shutter Actuator. The full range of functionality is available, particularly the exact positioning of the shutter/blind and the use of status messages from the drive.

In parallel operation with multiple addressing, up to 4 SMI drives can be connected to an output of the JA/S 4.SMI.1M. All connected drives can only be controlled as a group. This operating mode is particularly suitable for offices with 2 or more windows in which the blinds are operated in parallel. In parallel operation with multiple addressing, exact positioning is available just as with single operation. The status messages of the drive cannot however be uniquely evaluated as it is not possible to determine from which drive the message originates. Status messages can therefore only be used on a limited basis.

\* does not apply for JA/S 4.SMI.1M

### 4.1.3 Commissioning

No SMI knowledge is required for EIB/KNX commissioning. The Shutter Actuator JA/S 4.SMI.1M from ABB STOTZ-KONTAKT is connected to the EIB/KNX as well as to the SMI data cable and commissioned via the ETS.

All settings in the ETS program can be undertaken with the existing manual.



**4.1.4 SMI technical data****SMI interface**

Concept	One master (actuator), multiple slaves (drives)
Drive connection	5-lead installation cable without shielding
Number of SMI drives	1 to max. 16 per SMI output (max. 4 SMI drives per output with JA/S 4.SMI.1M)
Max. cable length	350 m
Topology	As required
Transmission rate	2,400 bit/s
Data transmission	Bidirectional
Operating modes	Single operation, parallel operation with multiple addressing, parallel operation with single addressing*

More detailed information concerning SMI technology can be found at [www.smi-group.com](http://www.smi-group.com).

\* does not apply for JA/S 4.SMI.1M

## 4.2 Manual operation

The SMI drives can be controlled using the manual buttons on the front of the device (see Fig. 21) even without an EIB/KNX connection. This functionality is particularly suitable for the commissioning of drives.



The manual control keys may not be operated with pointed or sharp-edged objects (e.g. screwdriver, pen, ...) which can damage the keypad.

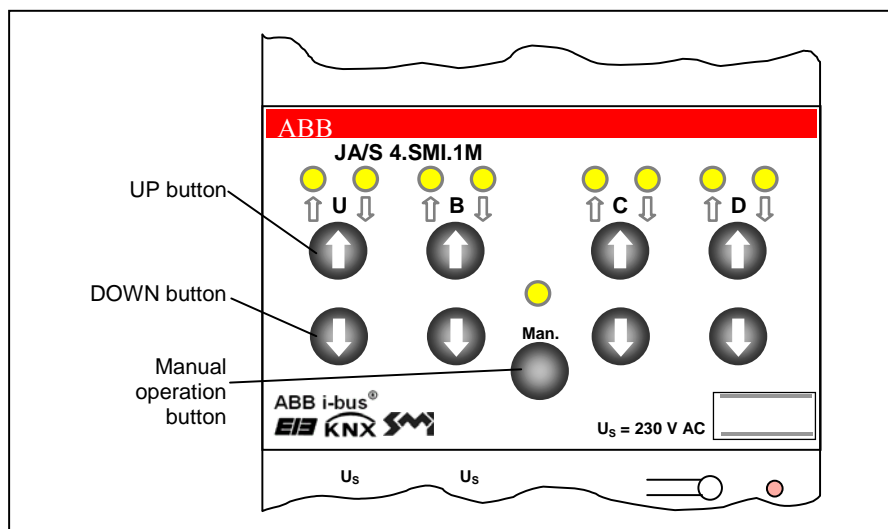

Fig. 21: Manual buttons JA/S 4.SMI.1M

### 4.2.1 Manual operating states

It is possible to switch between “manual operation” and “operation via EIB/KNX” by pressing the “Manual” button (Man.). With a long push button action (> 1 second), the device changes over to “manual operation”. With a short push button action (< 1 second), the device changes over to “operation via EIB/KNX”. The “Man.” LED lights up in the “manual operation” mode; in the “operation via EIB/KNX” mode the LED is switched off.

When switching over from “operation via EIB/KNX” to the “manual operation” mode, the corresponding LED quickly flashes three times after the “Man.” button is pressed. If manual operation has been enabled, the operating mode switches to “manual operation” and the LED is switched on. Manual operation can however also be disabled via the EIB/KNX. If manual operation is disabled, the LED switches off after flashing three times and the Shutter Actuator remains in the “operation via EIB/KNX” state.

The “Man.” button is pressed in order to switch from “manual operation” to “operation via EIB/KNX”. The “Man.” LED quickly flashes three times and the operating mode is toggled. Depending on the parameterisation, the operating state can switch back automatically to “operation via EIB/KNX” after a predefined time has elapsed. Likewise, the operating mode changes automatically to “operation via EIB/KNX” if manual operation is inhibited via an EIB/KNX telegram. The “Man.” button also quickly flashes three times when the operating state changes automatically.

In the “operation via EIB/KNX” mode, the connected drives can only be operated via the EIB/KNX. The UP/DOWN buttons on the device do not have a function.

In the “manual operation” state, the connected drives can be operated solely using the buttons on the device. Incoming telegrams on the EIB/KNX are not implemented, with the exception of telegrams to the “Safety” communication objects.

If an alarm is initiated by a “Safety” communication object (e.g. a wind alarm), the outputs concerned are moved to the corresponding safety position and can be operated via the manual buttons on the device.

#### 4.2.2 UP/DOWN buttons

In the “manual operation” mode, every output can be controlled individually via 2 keys (UP and DOWN). The keys have different functions depending on the operating mode. In the preset state (as supplied from the factory), the “Blinds” mode is set. Only one button can be activated at any one time.

##### “Blinds” mode

Long push button action (> 1 second) = move UP/DOWN: With a long operation of the upper button, the shutter/blind is moved upwards. With a long operation of the lower button, the shutter/blind is moved downwards.

Short push button action (< 1 second) = stop/louvre setting: If the shutter/blind is currently moving, movement can be stopped by briefly pressing one of the two keys. If the shutter/blind is currently at rest, a louvre adjustment upwards or downwards can be undertaken by briefly pressing the keys.

##### Mode “Shutter”

Long push button action (> 1 second) = move UP/DOWN: With a long operation of the upper button, the shutter/blind is moved upwards. With a long operation of the lower button, the shutter/blind is moved downwards.

Short push button action (< 1 second) = stop: If the shutter/blind is currently moving, movement can be stopped by briefly pressing one of the two keys. If the shutter/blind is currently at rest, a short operation of the button will not initiate a function.

### 4.2.3 LED display

The status of outputs A-D and the manual operation is displayed via the LEDs on the front of the device (see Fig. 22). The display is the same for the “manual operation” and “operation via EIB/KNX” operating modes.



The LEDs are used exclusively as a status display of the shutter/blind and of the operating state. They are not intended for control of the shutter/blind and may not be pressed/actuated.

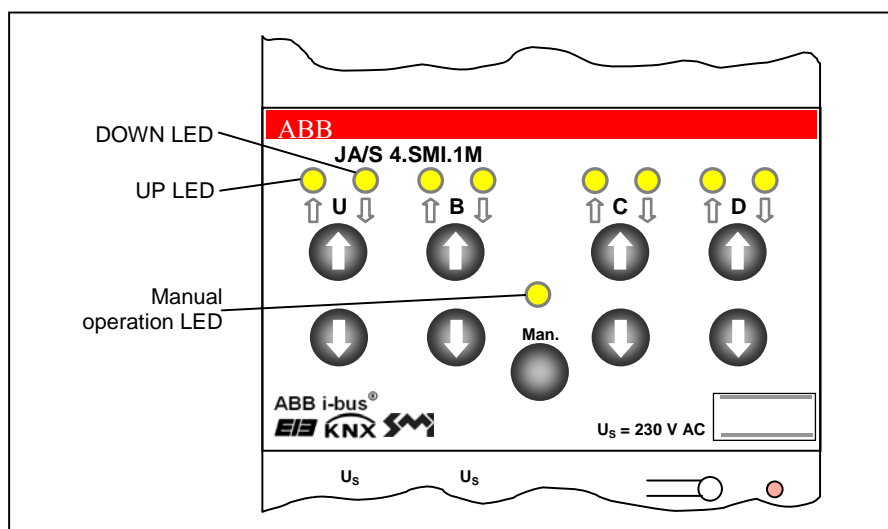

Fig. 22: LED display JA/S 4.SMI.1M

#### UP LED or DOWN LED flashes:

If the shutter/blind is moving upwards, the UP LED will flash.  
If the shutter/blind is moving downwards, the DOWN LED will flash.

#### UP LED or DOWN LED is on:

If the shutter/blind has reached the upper end position, the UP LED is on.  
If the shutter/blind has reached the lower end position, the DOWN LED is on.

#### UP LED and DOWN LED are off:

The shutter/blind is in an intermediate position or the 230 V auxiliary voltage is not present.

#### Both LEDs of a channel “slowly” flash alternately:

If both LEDs “slowly” flash alternately (1 x flash per second), a safety function has triggered an alarm for the corresponding output (e.g. a wind alarm). This output cannot be operated via the buttons on the device as long as the alarm is active.

#### Both LEDs of a channel “quickly” flash alternately:

If both LEDs “quickly” flash alternately (2 x flash per second), the SMI communication is disrupted.

Possible sources of error:

- No drive(s) connected to the output
- 230 V auxiliary voltage not available
- SMI data cable damaged

**Both LEDs of a channel flash simultaneously**

If both LEDs of a channel flash simultaneously, more SMI drives than admissible (max. 4 SMI drives) have been connected to the corresponding channel.

**Man. operation LED**

If the LED is off, the device is in the “operation via EIB/KNX” operating state.

If the LED is on, the device is in the “manual operation” operating state.

If the LED flashes, the device is currently toggling between EIB/KNX and manual operation.

Possible states of the display LEDs are compiled in the following table:

“Man.” LED	UP LED output A-D	DOWN LED output A-D	Status
-	Flashes	OFF	Shutter/blind moving upwards
-	OFF	flashes	Shutter/blind moving downwards
-	On	OFF	Shutter/blind in upper end position
-	OFF	On	Shutter/blind in lower end position
-	OFF	OFF	Shutter/blind in intermediate position
-	“Slow” alternate flash		Operation inhibited, alarm
-	“Fast” alternate flash		No SMI communication
-	Flash simultaneously		Inadmissible number of SMI drives
OFF	-	-	Operating state “operation via EIB/KNX”
On	-	-	Operating state “manual operation”
Flashes	-	-	Toggling between “operation via EIB/KNX” and “manual operation”

Table 3: LED states

### 4.3 Move to position

#### 4.3.1 Move to position 0% ... 100%

The shutter/blind can be moved into any position via an 8-bit value. In the “Blinds” operating mode, the louvres can also be positioned into any angle via an 8-bit value.

In this way, it can be decided for each movement command which position the shutter/blind should move into. For example, it is possible to set the position from a display unit or a visualisation terminal (see Fig. 23).

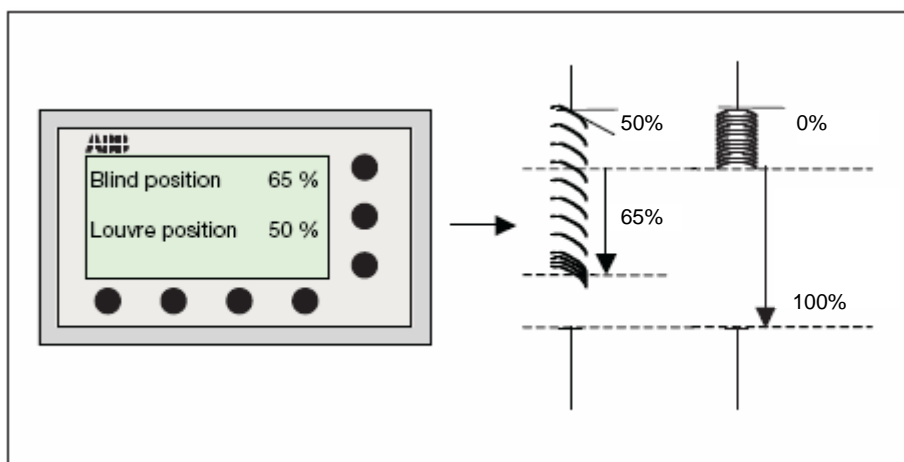

Fig. 23: Move to position 0...100 %

#### 4.3.2 Move to preset position

It is possible to parameterise up to 4 preset positions individually for each output in the Shutter Actuator, which are then recalled via a 1-bit command.

When moving into one of these preset positions, the target position must first be set, either via the parameters during programming or via the function “Set preset position” (see also chapter 4.3.3). This preset target position can then for example be recalled as often as required by pressing a switch sensor (see Fig. 24).

### 4.3.3 Set preset position

The preset position can be changed very easily via a 1-bit command. To do so, the shutters/blinds are moved via UP/DOWN commands as well as STOP/louvre adjustment commands into the required new preset position. The new position is adopted via a 1-bit command as a new preset position into the memory of the Shutter Actuator.

Application example: The shutters are moved into a preset position after a short push button action and the current position is adopted as the new preset position after a long push button action (Fig. 24).

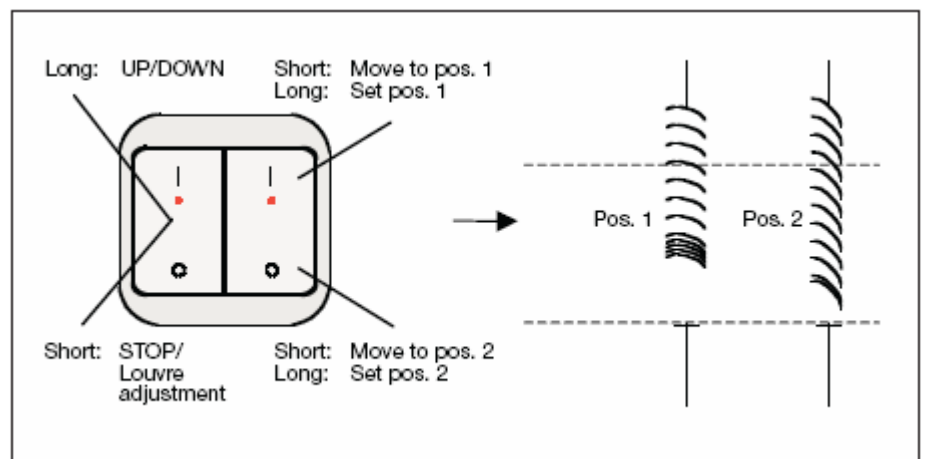

Fig. 24: Move to preset position and save preset position

The saved preset values are retained with a bus voltage failure. With the programming it is possible to set via a parameter if the saved values should be overwritten by the parameterised values.

## 4.4 Automatic control

### 4.4.1 Automatic sun protection

#### Function

Together with other EIB/KNX components, a very convenient automatic sun control function can be established with the Shutter Actuator. The automatic sun protection controls the shutter/blind according to the level of sunlight. Depending on the strength and direction of the sun, the shutter/blind is moved into a set position via an 8-bit value or into a variable position depending on the situation.

For example, the blinds can be moved upwards if the sunshine is very weak or if the window concerned is in the shadows. As much light as possible is thereby let into the room without any disruptive direct sunlight being taken into account. If there is blazing sun on the window however, the blind is lowered and the louvres are closed to the extent that direct sunlight cannot penetrate the room. The residual opening in the blinds lets in a sufficient level of diffuse light into the room (see Fig. 25).

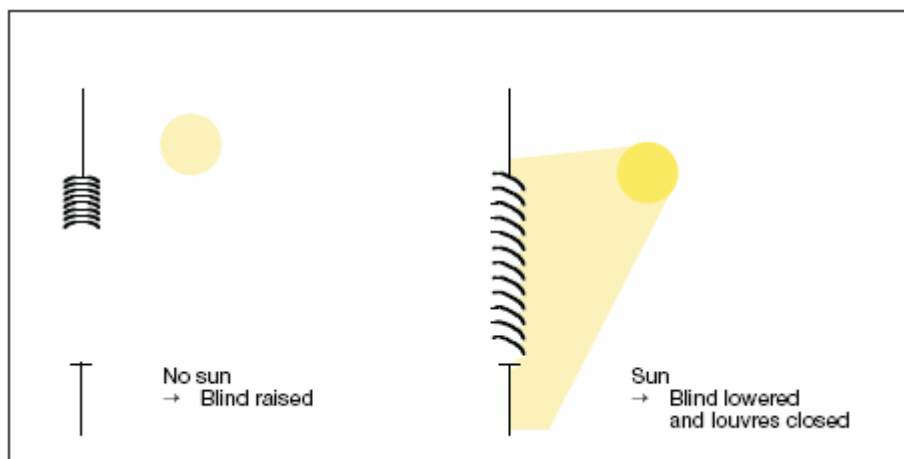

Fig. 25: Method of functioning of an automatic sun protection system

When using special directional louvres, the direct light into the room is guided so that no disruptive direct light penetrates the room but at the same time optimum use is made of the existing natural daylight (see Fig. 26).

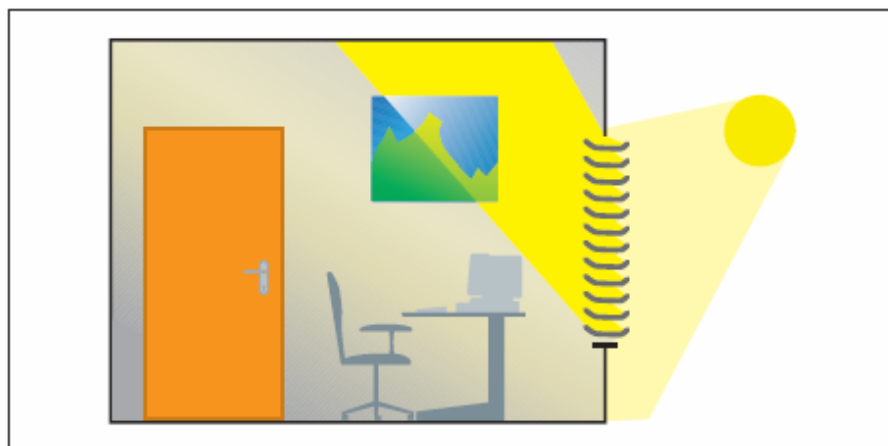

Fig. 26: Direction of daylight



**Setting up a simple automatic sun protection system**

Two further components are required in addition to the Shutter Actuator and switch sensor in order to set up a simple automatic control system: an activation option for the user (e.g. a further switch sensor or the second rocker of the UP/DOWN switch sensor) and a brightness sensor. With the help of the second switch sensor, the user of the room can specify whether he wishes to use the automatic sun protection or whether he would rather control the shutters/blinds manually. If the automatic sun protection is activated via a switch sensor, the shutter/blind moves automatically until either the automatic sun protection is deactivated via the same switch sensor or the user issues a direct movement command (e.g. UP/DOWN or move into position) and the automatic function is thus also deactivated.

The Shutter Actuator receives the information via the brightness sensor as to whether there is direct sunlight on the window or the façade. Once the adjustable delay period has elapsed, the Shutter Actuator positions the shutter/blind according to the set "Position for sun = "1" (sun)" or "Position for sun = "0" (no sun)" (see Fig. 27).

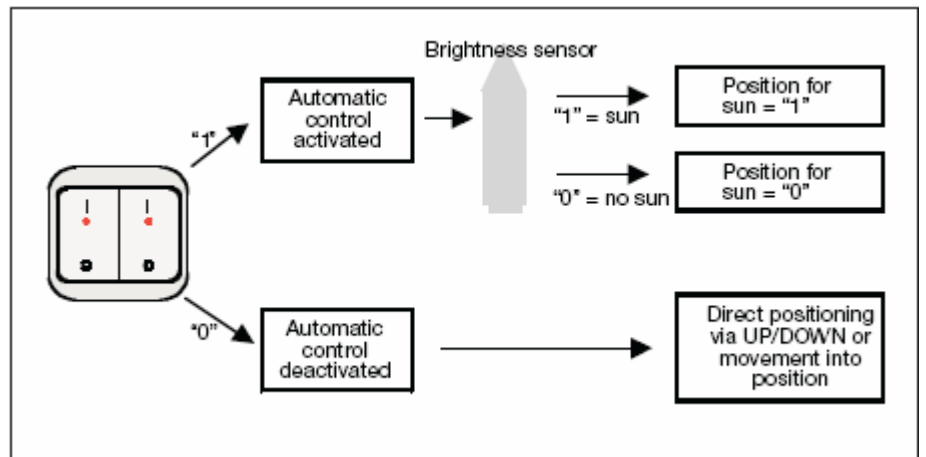

Fig. 27: Setting up a simple automatic sun protection system

**Planning a simple automatic sun protection system**

To set up an automatic sun protection system with tracking of the sun's position, the following EIB/KNX components are required (see also Fig. 28):

- Shutter Actuator
- EIB/KNX switch sensor or universal interface + push button
- Brightness sensor

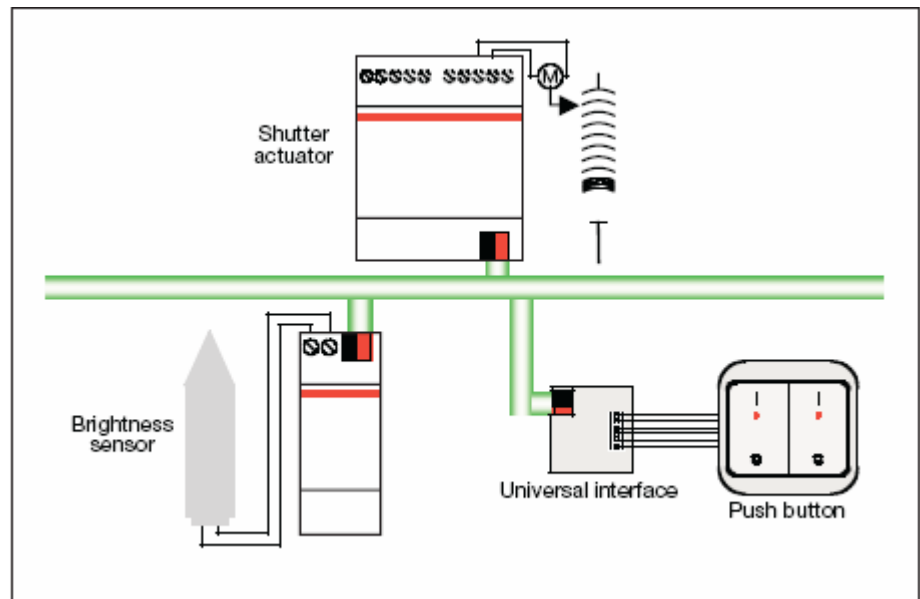

Fig. 28: Planning a simple automatic sun protection system

**Design of an automatic sun protection system with tracking of the sun's position**

To set up an automatic sun protection system with tracking of the sun's position, an additional control unit is required (e.g. the Shutter Control Unit JSB/S 1.1).

The current position of the sun is continually calculated in the shutter control unit. The shutter/blind is moved via an 8-bit value into the optimum position to deflect direct sunshine but to let through as much diffuse light as possible. The influence of shadows e.g. the buildings opposite can also be taken into account in the shutter control unit (see Fig. 29).

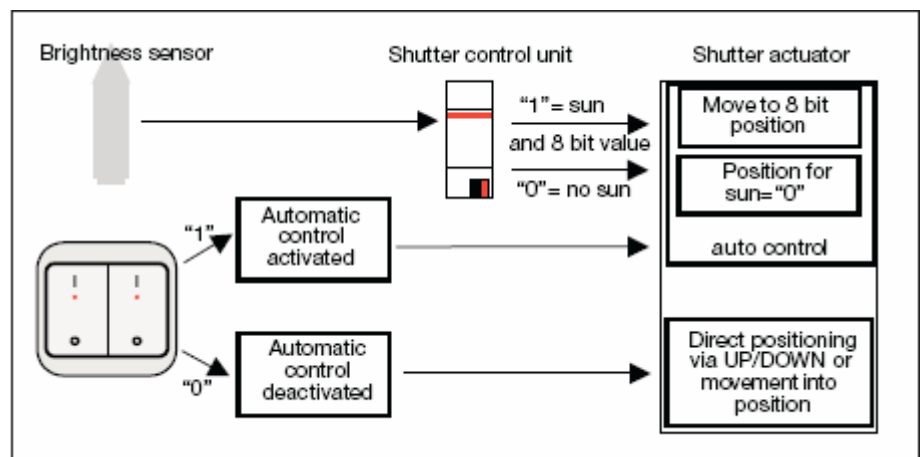

Fig. 29: Design of an automatic sun protection system with tracking of the sun's position

### Planning a simple automatic sun protection system with tracking of the sun's position

The following EIB/KNX components are required for setting up an automatic sun protection system (including automatic sun protection with tracking of the sun's position (see also Fig. 30):

- Shutter Actuator
- EIB/KNX switch sensor or universal interface + conventional push button
- Brightness sensor
- Shutter control unit

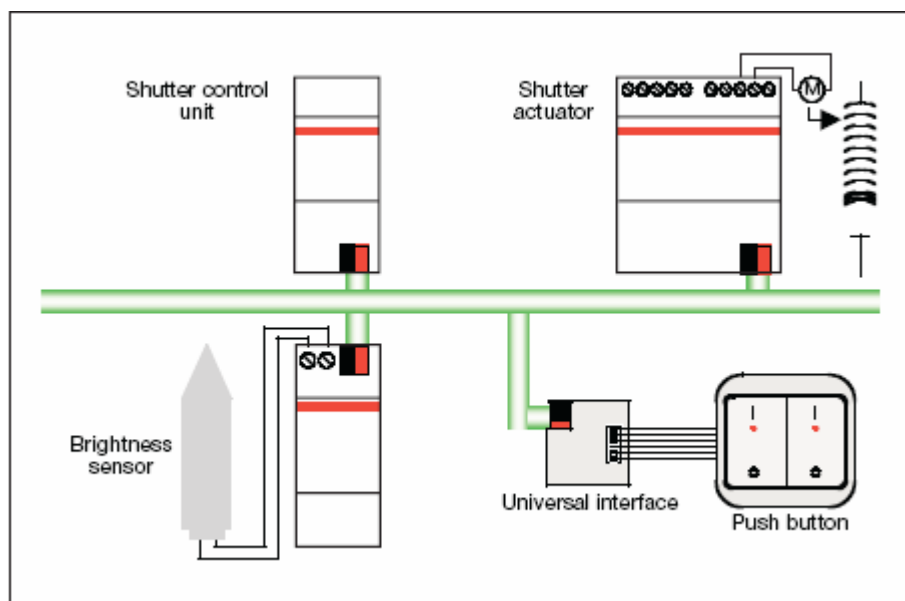

Fig. 30: Planning of an automatic sun protection system with tracking of the sun's position

The current position of the sun is calculated based on the time of day. The shutter control unit can be operated as an independent clock, as a master clock or as a slave clock on the EIB/KNX. Several shutter control units can also be synchronised together. If the shutter control unit is operated as an independent clock or as a master clock, no further time switches are required for blind/shutter control.

The shutter control unit can likewise be operated as a slave clock if for example a master clock is present in the installation. A time switch which can send the time and date on the EIB/KNX must be used as a master clock, if an additional time switch is added to the system.

#### 4.4.2 Automatic heating/cooling

##### Function

The automatic heating/cooling control controls the shutter/blinds according to the sun's rays and the required energy input requirement into the room. The shutter/blind is moved into a set position depending on whether the room should be heated or cooled and how strong the sun is and in which direction it is shining. The shutter can for example be raised during the heating phase when the sun is shining to achieve a maximum energy input into the room. If there is no sun, for example during the night, an internal blind is closed which ensures that the heat collected during the day is not completely lost during night reduction (see Fig. 28). During the cooling phase, the blind can be lowered during full sunshine in order to keep the energy input at a minimum. During the night, a reduction in the room temperature in an air-conditioned room to the external temperature can likewise be counteracted by the use of an internal blind (see Fig. 31).

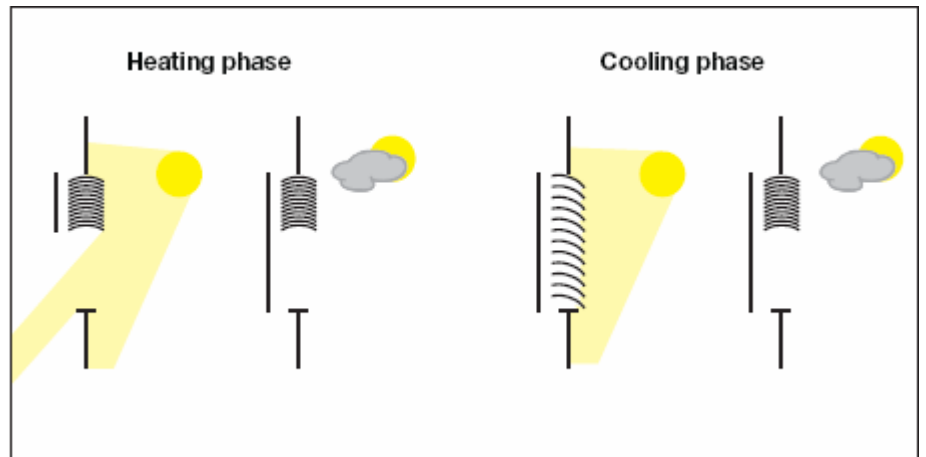

Fig. 31: Method of functioning of an automatic heating/cooling control system

### Setup

Two further components are required in addition to the Shutter Actuator and switch sensor in order to set up an automatic heating/cooling control system: a toggling option between automatic sun protection and automatic heating/cooling (e.g. a presence detector) as well as a toggling option between heating and cooling (e.g. a year time switch or a temperature sensor).

With the help of the switch sensor, the user of the room can specify whether he wishes to use the automatic control or whether he would rather control the shutters/blinds manually. If the automatic sun protection is activated via a switch sensor, the shutter/blind moves automatically until either the automatic function is deactivated via the same switch sensor or the user issues a direct movement command (e.g. UP/DOWN or move into position) and the automatic function is thus also deactivated.

The Shutter Actuator receives the information via the presence detector as to whether there are people in the room. If the room is occupied, the blind is controlled according to the automatic sun protection function. If nobody is in the room, the blind is controlled according to the automatic heating/cooling function.

For example, the Shutter Actuator receives the information via a year time switch or a thermostat as to whether the room should be heated or cooled. The blind moves into the set heating or cooling position, depending on the position and intensity of the sun (see Fig. 32).

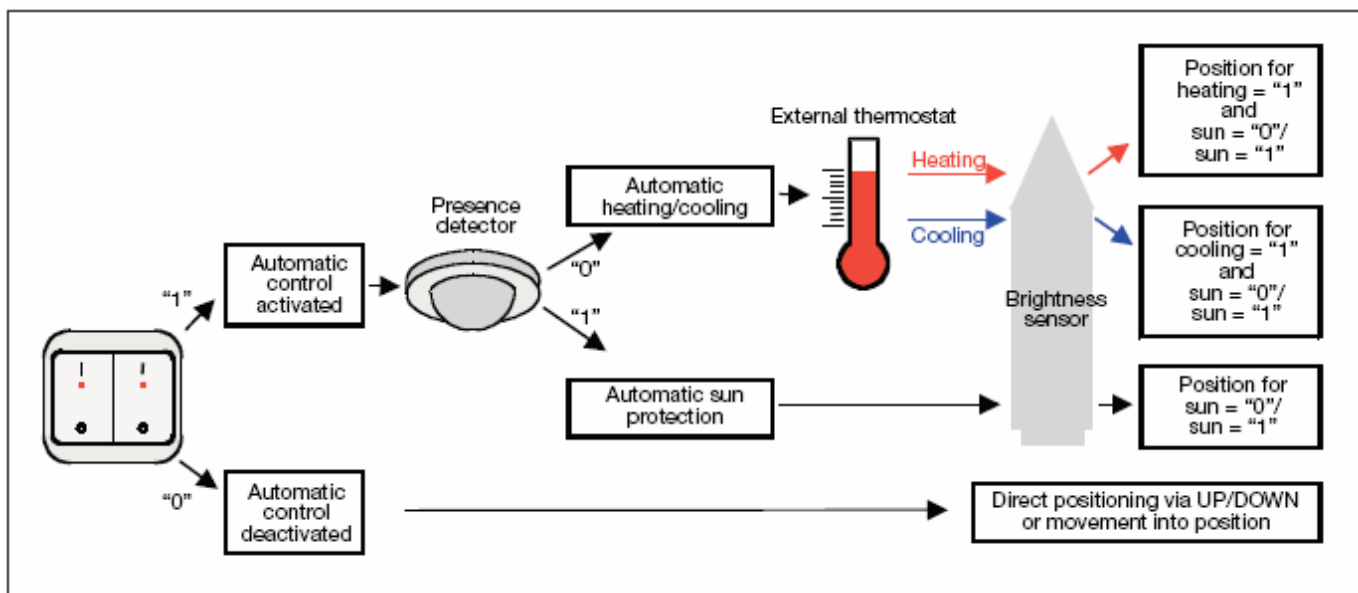

Fig. 32: Setting up an automatic/heating control system

### Planning information

The following EIB/KNX components are required for setting up an automatic heating/control system (including automatic sun protection with tracking of the sun's position (see also Fig. 33):

- Shutter Actuator
- EIB/KNX switch sensor or universal interface + push button
- EIB/KNX presence detector or universal interface + presence detector
- Brightness sensor
- Shutter control unit
- Thermostat

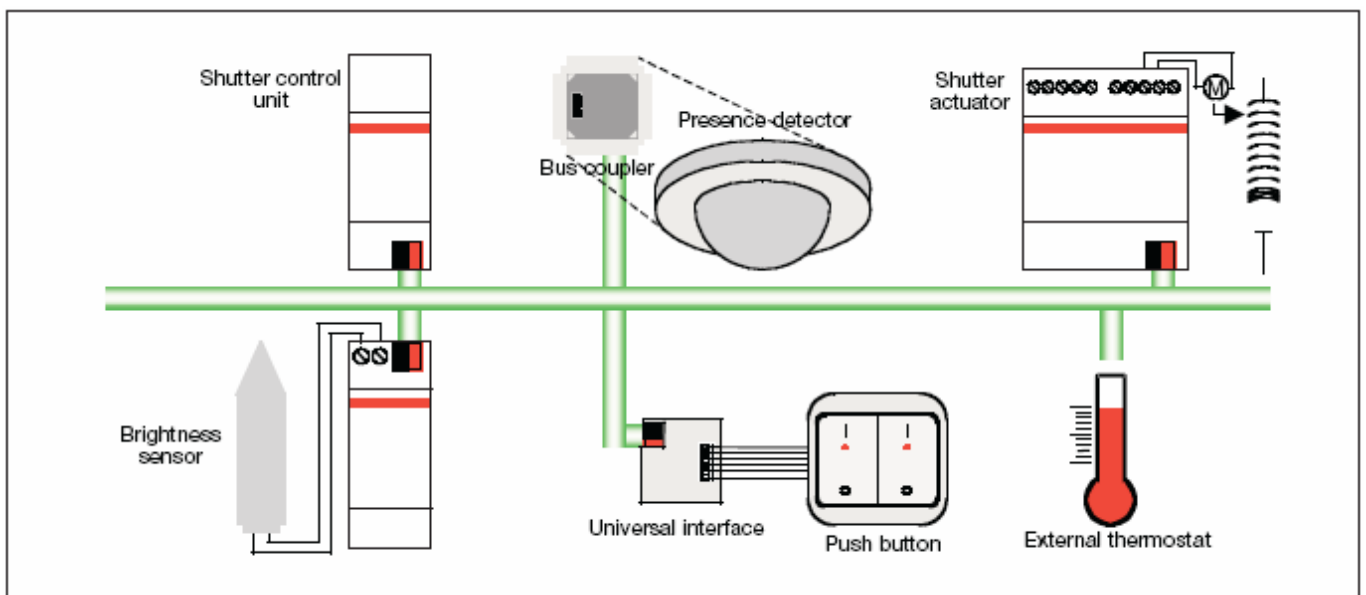

Fig. 33: Planning of an automatic heating/cooling control system

The automatic heating/cooling control function for shutters/blinds is predominantly carried out independently of the individual room temperature control. Optimum use is made of the sun as an energy source for controlling the blinds, thereby saving energy. The remaining temperature differential to the setpoint temperature is balanced out via the individual room temperature control.

As a result, if a room should be protected all day against the sunlight for example, the air conditioning system only occasionally cools down the room via a 2-step controller. In this case, the control of the air conditioning system is independent of the control of the shutter/blind.

The same room thermostat should therefore not be used for controlling the blinds but rather an external thermostat or a year time switch (e.g. heating period from November to March, cooling period from June to August). A time switch with 1-bit commands is sufficient for automatic heating/cooling. If the time switch should also be used simultaneously as a master clock for automatic sun protection with tracking of the sun's position, it must also be able to send the time and the date on the EIB/KNX.

## 5 Appendix

### 5.1 Status byte – code table

Bit No.		7	6	5	4	3	2	1	0		
Status byte value (decimal)	Hexadecimal	Automatic heating/cooling	Automatic sun protection	Wind alarm	Rain alarm	Frost alarm	Forced positioning	Block	Manual operation	Current status	Operation
0	00	0	0	0	0	0	0	0	0	Direct positioning	Via the communication objects: - Up/Down - Stop/Louvre adjustment - Move to position - Scene
1	01	0	0	0	0	0	0	0	1	Manual operation	Via device buttons
2	02	0	0	0	0	0	0	1	0	Block	blocked
4	04	0	0	0	0	0	1	0	0	Forced positioning	blocked
8	08	0	0	0	0	1	0	0	0	Frost alarm	blocked
16	10	0	0	0	1	0	0	0	0	Rain alarm	blocked
32	20	0	0	1	0	0	0	0	0	Wind alarm	blocked
64	40	0	1	0	0	0	0	0	0	Automatic sun protection	Via the communication objects: - Sun - Sun position - Sun louvre
128	80	1	0	0	0	0	0	0	0	Automatic heating/cooling	Via the communication objects: - Heating - Cooling
Other	Other	X	X	X	X	X	X	X	X	Not defined	

Table 4: Status byte – code table



5.2 Diagnostic byte code table

Diagnostic value	Hexadecimal	No communication	Motor moves up	Motor moves down	Motor fault	Short circuit on SMI (hardware fault)	At least one drive cannot be identified via its ID	Less drives detected than configured	More than 4 drives detected on SMI
0	00								
1	01								
2	02								
3	03								
4	04								
5	05								
6	06								
7	07								
8	08								
9	09								
10	0A								
11	0B								
12	0C								
13	0D								
14	0E								
15	0F								
16	10								
17	11								
18	12								
19	13								
20	14								
21	15								
22	16								
23	17								
24	18								
25	19								
26	1A								
27	1B								
28	1C								
29	1D								
30	1E								
31	1F								
32	20								
33	21								
34	22								
35	23								
36	24								
37	25								
38	26								
39	27								
40	28								
41	29								
42	2A								
43	2B								
44	2C								
45	2D								
46	2E								
47	2F								
48	30								
49	31								
50	32								
51	33								
52	34								
53	35								
54	36								
55	37								
56	38								
57	39								
58	3A								
59	3B								
60	3C								
61	3D								
62	3E								
63	3F								
64	40								
65	41								
66	42								
67	43								
68	44								
69	45								
70	46								
71	47								
72	48								
73	49								
74	4A								
75	4B								
76	4C								
77	4D								
78	4E								
79	4F								
80	50								
81	51								
82	52								
83	53								
84	54								
85	55								

Diagnostic value	Hexadecimal	No communication	Motor moves up	Motor moves down	Motor fault	Short circuit on SMI (hardware fault)	At least one drive cannot be identified via its ID	Less drives detected than configured	More than 4 drives detected on SMI
86	56								
87	57								
88	58								
89	59								
90	5A								
91	5B								
92	5C								
93	5D								
94	5E								
95	5F								
96	60								
97	61								
98	62								
99	63								
100	64								
101	65								
102	66								
103	67								
104	68								
105	69								
106	6A								
107	6B								
108	6C								
109	6D								
110	6E								
111	6F								
112	70								
113	71								
114	72								
115	73								
116	74								
117	75								
118	76								
119	77								
120	78								
121	79								
122	7A								
123	7B								
124	7C								
125	7D								
126	7E								
127	7F								
128	80								
129	81								
130	82								
131	83								
132	84								
133	85								
134	86								
135	87								
136	88								
137	89								
138	8A								
139	8B								
140	8C								
141	8D								
142	8E								
143	8F								
144	90								
145	91								
146	92								
147	93								
148	94								
149	95								
150	96								
151	97								
152	98								
153	99								
154	9A								
155	9B								
156	9C								
157	9D								
158	9E								
159	9F								
160	A0								
161	A1								
162	A2								
163	A3								
164	A4								
165	A5								
166	A6								
167	A7								
168	A8								
169	A9								
170	AA								
171	AB								

Diagnostic value	Hexadecimal	No communication	Motor moves up	Motor moves down	Motor fault	Short circuit on SMI (hardware fault)	At least one drive cannot be identified via its ID	Less drives detected than configured	More than 4 drives detected on SMI
172	AC								
173	AD								
174	AE								
175	AF								
176	B0								
177	B1								
178	B2								
179	B3								
180	B4								
181	B5								
182	B6								
183	B7								
184	B8								
185	B9								
186	BA								
187	BB								
188	BC								
189	BD								
190	BE								
191	BF								
192	C0								
193	C1								
194	C2								
195	C3								
196	C4								
197	C5								
198	C6								
199	C7								
200	C8								
201	C9								
202	CA								
203	CB								
204	CC								
205	CD								
206	CE								
207	CF								
208	D0								
209	D1								
210	D2								
211	D3								
212	D4								
213	D5								
214	D6								
215	D7								
216	D8								
217	D9								
218	DA								
219	DB								
220	DC								
221	DD								
222	DE								
223	DF								
224	E0								
225	E1								
226	E2								
227	E3								
228	E4								
229	E5								

5.3 8-bit scene code table

Bit no.	7	6	5	4	3	2	1	0	Scene number	Invoke (A)
8-bit value	Hexadecimal	Recall	not defined	Scene number				Scene number	Invoke (A)	
0	00							1	A	
1	01							2	A	
2	02							3	A	
3	03							4	A	
4	04							5	A	
5	05							6	A	
6	06							7	A	
7	07							8	A	
8	08							9	A	
9	09							10	A	
10	0A							11	A	
11	0B							12	A	
12	0C							13	A	
13	0D							14	A	
14	0E							15	A	
15	0F							16	A	
16	10							17	A	
17	11							18	A	
18	12							19	A	
19	13							20	A	
20	14							21	A	
21	15							22	A	
22	16							23	A	
23	17							24	A	
24	18							25	A	
25	19							26	A	
26	1A							27	A	
27	1B							28	A	
28	1C							29	A	
29	1D							30	A	
30	1E							31	A	
31	1F							32	A	
32	20							33	A	
33	21							34	A	
34	22							35	A	
35	23							36	A	
36	24							37	A	
37	25							38	A	
38	26							39	A	
39	27							40	A	
40	28							41	A	
41	29							42	A	
42	2A							43	A	
43	2B							44	A	
44	2C							45	A	
45	2D							46	A	
46	2E							47	A	
47	2F							48	A	
48	30							49	A	
49	31							50	A	
50	32							51	A	
51	33							52	A	
52	34							53	A	
53	35							54	A	
54	36							55	A	
55	37							56	A	
56	38							57	A	
57	39							58	A	
58	3A							59	A	
59	3B							60	A	
60	3C							61	A	
61	3D							62	A	
62	3E							63	A	
63	3F							64	A	

Bit no.	7	6	5	4	3	2	1	0	Scene number	Save (S)
8-bit value	Hexadecimal	Save	not defined	Scene number				Scene number	Save (S)	
128	80							1	S	
129	81							2	S	
130	82							3	S	
131	83							4	S	
132	84							5	S	
133	85							6	S	
134	86							7	S	
135	87							8	S	
136	88							9	S	
137	89							10	S	
138	8A							11	S	
139	8B							12	S	
140	8C							13	S	
141	8D							14	S	
142	8E							15	S	
143	8F							16	S	
144	90							17	S	
145	91							18	S	
146	92							19	S	
147	93							20	S	
148	94							21	S	
149	95							22	S	
150	96							23	S	
151	97							24	S	
152	98							25	S	
153	99							26	S	
154	9A							27	S	
155	9B							28	S	
156	9C							29	S	
157	9D							30	S	
158	9E							31	S	
159	9F							32	S	
160	A0							33	S	
161	A1							34	S	
162	A2							35	S	
163	A3							36	S	
164	A4							37	S	
165	A5							38	S	
166	A6							39	S	
167	A7							40	S	
168	A8							41	S	
169	A9							42	S	
170	AA							43	S	
171	AB							44	S	
172	AC							45	S	
173	AD							46	S	
174	AE							47	S	
175	AF							48	S	
176	B0							49	S	
177	B1							50	S	
178	B2							51	S	
179	B3							52	S	
180	B4							53	S	
181	B5							54	S	
182	B6							55	S	
183	B7							56	S	
184	B8							57	S	
185	B9							58	S	
186	BA							59	S	
187	BB							60	S	
188	BC							61	S	
189	BD							62	S	
190	BE							63	S	
191	BF							64	S	

Table 6: 8-bit scene code table

## 5.4 List of drawings

Fig. 1:	JA/S 4.SMI.1M.....	5
Fig. 2:	Wiring diagram JA/S 4.SMI.1M .....	6
Fig. 3:	Dimension drawing JA/S 4.SMI.1M .....	7
Fig. 4:	Parameter window "General".....	10
Fig. 5:	Parameter window "Manual".....	14
Fig. 6:	Parameter window "EIB/KNX" .....	17
Fig. 7:	Parameter window "Weather".....	21
Fig. 8:	Parameter window "SMI Drives".....	23
Fig. 9:	Parameter window "Output A-D" .....	24
Fig. 10:	Rotation angle of the motor shaft .....	25
Fig. 11:	Parameter window "Safety" .....	28
Fig. 12:	Parameter window "Status" .....	31
Fig. 13:	Parameter window "Position" .....	35
Fig. 14:	Parameter window "Position 1-4" .....	37
Fig. 15:	Parameter window "Auto 1" .....	39
Fig. 16:	Parameter window "Auto 2" .....	44
Fig. 17:	Parameter window "Output A-D" scene.....	46
Fig. 18:	Parameter window "A-D" scene.....	47
Fig. 19:	Communication objects "Output A-D".....	49
Fig. 20:	Communication objects "General" .....	58
Fig. 21:	Manual buttons JA/S 4.SMI.1M .....	64
Fig. 22:	LED display JA/S 4.SMI.1M .....	66
Fig. 23:	Move to position 0...100 % .....	68
Fig. 24:	Move to preset position and save preset position .....	69
Fig. 25:	Method of functioning of an automatic sun protection system .....	70
Fig. 26:	Direction of daylight .....	70
Fig. 27:	Setting up a simple automatic sun protection system .....	71
Fig. 28:	Planning a simple automatic sun protection system .....	72
Fig. 29:	Design of an automatic sun protection system with tracking of the sun's position.....	73
Fig. 30:	Planning of an automatic sun protection system with tracking of the sun's position.....	74
Fig. 31:	Method of functioning of an automatic heating/cooling control system.....	75
Fig. 32:	Setting up an automatic/heating control system.....	76
Fig. 33:	Planning of an automatic heating/cooling control system .....	77

## 5.5 List of tables

Table 1:	Technical data .....	6
Table 2:	Application program.....	6
Table 3:	LED states .....	67
Table 4:	Status byte – code table .....	78
Table 5:	Diagnostic byte code table .....	79
Table 6:	8-bit scene code table .....	80

**5.6 Ordering information**

<b>Short description</b>	Designation	Order No.	<b>bbn 40 16779 EAN</b>	Price group	Unit weight 1 pc.[kg]	Pack unit [Pcs]
<b>JAS 4.SMI.1M</b>	Shutter Actuator with manual operation, 4-fold, SMI, MDRC	2CDG 110 028 R0011	65423 4	26	0.25	1



The information in this leaflet is subject to change without further notice.

Pub. No. 2CDC 506 036 D0201 V1-1

Your EIB-Partner

--	--	--